

Harmony XB5 Display Modules

XB5DD030/050

User Manual

(Original Document)

10/2019



E100000003967.00

www.schneider-electric.com

Schneider
Electric



RSPSupply - 1-888-532-2706 - <https://www.RSPSupply.com>
See the product details here

The information provided in this documentation contains general descriptions and/or technical characteristics of the performance of the products contained herein. This documentation is not intended as a substitute for and is not to be used for determining suitability or reliability of these products for specific user applications. It is the duty of any such user or integrator to perform the appropriate and complete risk analysis, evaluation and testing of the products with respect to the relevant specific application or use thereof. Neither Schneider Electric nor any of its affiliates or subsidiaries shall be responsible or liable for misuse of the information contained herein. If you have any suggestions for improvements or amendments or have found errors in this publication, please notify us.

You agree not to reproduce, other than for your own personal, noncommercial use, all or part of this document on any medium whatsoever without permission of Schneider Electric, given in writing. You also agree not to establish any hypertext links to this document or its content. Schneider Electric does not grant any right or license for the personal and noncommercial use of the document or its content, except for a non-exclusive license to consult it on an "as is" basis, at your own risk. All other rights are reserved.

All pertinent state, regional, and local safety regulations must be observed when installing and using this product. For reasons of safety and to help ensure compliance with documented system data, only the manufacturer should perform repairs to components.

When devices are used for applications with technical safety requirements, the relevant instructions must be followed.

Failure to use Schneider Electric software or approved software with our hardware products may result in injury, harm, or improper operating results.

Failure to observe this information can result in injury or equipment damage.

© 2019 Schneider Electric. All rights reserved.

Table of Contents



	Safety Information	7
	About the Book	9
Chapter 1	System Design	11
	System Design Overview	12
	Standard System Design	13
	Option System Design	14
	Advanced System Design	15
Chapter 2	XB5DD030/050	17
	XB5DD030/050 of Harmony Displays	18
	XB5DD030/050 Package Contents	21
	Accessories	22
	Parts Identification and Functions	23
	Certifications and Standards	26
Chapter 3	Specifications	29
3.1	General Specifications	30
	General Specifications	30
3.2	Functional Specifications	32
	Display	33
	Touch Panel	34
3.3	Interface Specifications	35
	Interface Specifications	36
	Specifications of Serial Interface COM1	37
3.4	Dimensions	38
	XB5DD030/050	38
Chapter 4	Installation and Wiring	43
4.1	Installation	44
	Harmony Display Cut-Out Dimensions and Installation	45
	Installation Procedures	49
4.2	Wiring Principles	54
	Connecting the Power Cord	55
	Connecting the Power Supply	58
	Grounding	60
4.3	USB Ports	62
	USB Ports Overview	62

4.4	Serial Communication Port	63
	Serial Communication Port	63
4.5	Ethernet Cable Connector	64
	Presentation	64
4.6	System Wiring	65
	Standard System	66
	Option System Design	68
	Advanced System Design	72
4.7	SD Card Management	73
	SD Card Management	73
Chapter 5	Configuring the Unit	75
	Types of Settings	76
	System Settings	77
Chapter 6	Configuring the Application	79
6.1	Settings Pages Flowchart	80
	Settings Pages Flowchart	81
	Overview	83
6.2	Settings Pages	84
	Setting Page: Password	85
	Setting Page: Welcome	86
	Setting Page: Language	87
	Setting Page: Communication	88
	Setting Page: Analog Value 1 and 2	90
	Setting Page: Analog Value 3 and 4	95
	Setting Page: Cam Switch	100
	Setting Page: Digital Inputs 1...4	102
	Setting Page: Digital Inputs 5...8	105
	Setting Page: Notifications	106
	Setting Page: Password	107
	Setting Page: Save	108
	Setting Page: Theme	109
Chapter 7	RUN MODE	111
	Overview	112
	Main Pages	114
	Analog Thresholds	119
	SetPoint	121
Chapter 8	Memory Mapping	125
	Memory Mapping	125

Chapter 9	Maintenance	131
	Regular Cleaning	132
	Periodic Check Points	134
Chapter 10	Troubleshooting	135
	Troubleshooting Checklists	135
Index	137



Safety Information



Important Information

NOTICE

Read these instructions carefully, and look at the equipment to become familiar with the device before trying to install, operate, service, or maintain it. The following special messages may appear throughout this documentation or on the equipment to warn of potential hazards or to call attention to information that clarifies or simplifies a procedure.



The addition of this symbol to a “Danger” or “Warning” safety label indicates that an electrical hazard exists which will result in personal injury if the instructions are not followed.



This is the safety alert symbol. It is used to alert you to potential personal injury hazards. Obey all safety messages that follow this symbol to avoid possible injury or death.

DANGER

DANGER indicates a hazardous situation which, if not avoided, **will result in** death or serious injury.

WARNING

WARNING indicates a hazardous situation which, if not avoided, **could result in** death or serious injury.

CAUTION

CAUTION indicates a hazardous situation which, if not avoided, **could result in** minor or moderate injury.

NOTICE

NOTICE is used to address practices not related to physical injury.

PLEASE NOTE

Electrical equipment should be installed, operated, serviced, and maintained only by qualified personnel. No responsibility is assumed by Schneider Electric for any consequences arising out of the use of this material.

A qualified person is one who has skills and knowledge related to the construction and operation of electrical equipment and its installation, and has received safety training to recognize and avoid the hazards involved.

About the Book



At a Glance

Document Scope

This manual describes how to use the:

- XB5DD030: Harmony XB5 Display module 3.5"
- XB5DD050: Harmony XB5 Display module 5.7"

Validity Note

This documentation is valid for the XB5DD030/050.

The technical characteristics of the devices described in the present document also appear online. To access the information online:

Step	Action
1	Go to the Schneider Electric home page www.schneider-electric.com .
2	In the Search box type the reference of a product or the name of a product range. <ul style="list-style-type: none">● Do not include blank spaces in the reference or product range.● To get information on grouping similar modules, use asterisks (*).
3	If you entered a reference, go to the Product Datasheets search results and click on the reference that interests you. If you entered the name of a product range, go to the Product Ranges search results and click on the product range that interests you.
4	If more than one reference appears in the Products search results, click on the reference that interests you.
5	Depending on the size of your screen, you may need to scroll down to see the datasheet.
6	To save or print a datasheet as a .pdf file, click Download XXX product datasheet .

The characteristics that are presented in the present document should be the same as those characteristics that appear online. In line with our policy of constant improvement, we may revise content over time to improve clarity and accuracy. If you see a difference between the document and online information, use the online information as your reference.

Product Related Information

WARNING

UNINTENDED EQUIPMENT OPERATION

The application of this product requires expertise in the design and programming of control systems. Only persons with such expertise should be allowed to program, install, alter, and apply this product.

Follow all local and national safety codes and standards.

Failure to follow these instructions can result in death, serious injury, or equipment damage.

WARNING

POTENTIAL COMPROMISE OF SYSTEM AVAILABILITY, INTEGRITY, AND CONFIDENTIALITY

- Change default passwords to help prevent unauthorized access to device settings and information.
- Disable unused ports/services and default accounts, where possible, to minimize pathways for malicious attacks.
- Place networked devices behind multiple layers of cyber defenses (such as firewalls, network segmentation, and network intrusion detection and protection).
- Use cyber security best practices (for example: least privilege, separation of duties) to help prevent unauthorized exposure, loss, modification of data and logs, interruption of services, or unintended operation.

Failure to follow these instructions can result in death, serious injury, or equipment damage.

Related Documents

Title of Documentation	Reference Number
Instruction sheet of XB5DD030/050	MFR86734
Instruction sheet of TM221C16R	EAV58623
Instruction sheet of TMC2 cartridges	EAV47884

You can download these technical publications and other technical information from our website at <https://www.se.com/ww/en/download/> .

Chapter 1

System Design

What Is in This Chapter?

This chapter contains the following topics:

Topic	Page
System Design Overview	12
Standard System Design	13
Option System Design	14
Advanced System Design	15

System Design Overview



Introduction

The Harmony Display can be install following two main system designs:

- Standard System: XB5DD030/050 connected to TM221C16R (see page 13)
- Option System: XB5DD030/050 connected to TM221C16R with a TMC2 cartridge (see page 14)
- Advanced System: XB5DD030/050 connected through Modbus RTU or TCP/IP (see page 15)

Overview

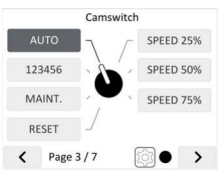
The Harmony Display is an HMI with an embedded application. Once configured, you can display analog and digital inputs and control analog and digital outputs.

Harmony Display screens		Description		Systems		
		Display functions	Actions on outputs	Standard	Option	Advanced
Analog 1		Displays analog value (from sensor). Sets a setpoint value	Controls a digital output (depending on thresholds of the analog value). ⁽¹⁾	✓	✓	✓ ⁽¹⁾
Analog 2				✓	✓	✓ ⁽¹⁾
Analog 3				-	✓ ⁽¹⁾	✓ ⁽¹⁾
Analog 4				-	✓ ⁽¹⁾	✓ ⁽¹⁾
Cam switch		Sets the cam switch position.	Controls digital outputs (depending on cam switch position).	✓	Up to 5 outputs	✓ Up to 7 outputs
Digital inputs 1...4		Displays digital inputs as pilot lights and texts, counters, or hour-counters.	-	✓	✓	✓
Digital inputs 5...8			-	✓	✓	✓
1 For Option system (with the TMC2AQ2• cartridges) and for Advanced system, the Harmony Display can control analog outputs with the setpoints.						

Standard System Design

Standard System: XB5DD030/050 Connected to TM221C16R

Standard system is a ready-to-use system. You have to purchase separately:

- The XB5DD030/050 display
- The ZBSD01 SD card
- The TM221C16R controller

No need to write program in XB5DD030/050 neither in TM221C16R.

To make standard system running, you have to install the dedicated program from the ZBSD01 into the TM221C16R.

Standard system architecture:

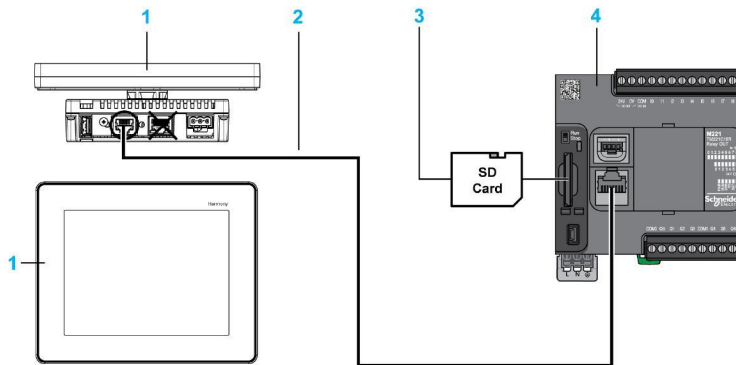

- 1 XB5DD030/050 unit
- 2 XBTZ9980 or XBTZ9982 cable for COM1 connection
- 3 ZBSD01 SD card that contains the TM221C16R program
- 4 TM221C16R logic controller

Commissioning

To commission the standard system, you have to:

- Load the program from the ZBSD01 SD card into the TM221C16R (*see page 73*)
- Wire correctly the system (*see page 66*)
- Configure the Harmony Display application. (*see page 79*)

Option System Design

Overview

Option system is a ready-to-use system. You have to purchase separately:

- The XB5DD030/050 display
- The ZBSD01 SD card
- The TM221C16R controller
- One TMC2 cartridge (for the TM221C16R controller) to add analog I/O:
 - TMC2TI2: 2 analog temperature inputs
 - TMC2AI2: 2 analog inputs (0...10 Vdc or 4...20 mA)
 - TMC2AQ2V: 2 analog voltage outputs (0...10 Vdc)
 - TMC2AQ2C: 2 analog current outputs (4...20 mA)

No need to write program in XB5DD030/050 neither in TM221C16R.

To make option system running, you have to install the dedicated program from the ZBSD01 into the TM221C16R.

Option System: XB5DD030/050 Connected to TM221C16R+TMC2 Cartridge

Option system architecture:

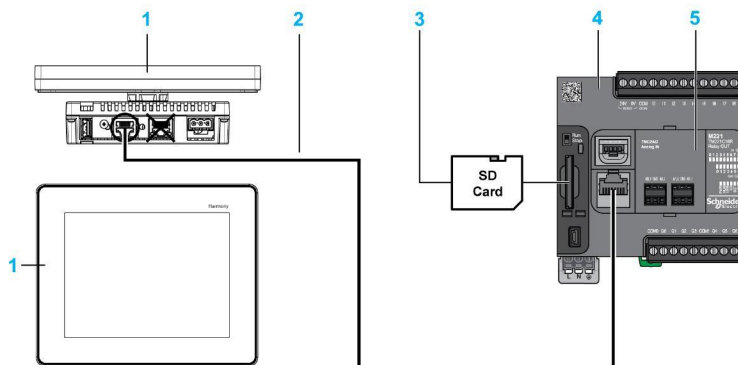

- 1 XB5DD030/050 unit
- 2 XBTZ9980 or XBTZ9982 cable for COM1 connection
- 3 ZBSD01 SD card that contains the TM221C16R programs
- 4 TM221C16R logic controller
- 5 Slot for TMC2 cartridge

Commissioning

To commission the option system, you have to:

- Load the appropriate program from the ZBSD01 SD card into the TM221C16R (*see page 73*)
- Wire correctly the system (*see page 66*)
- Configure the Harmony Display application. (*see page 79*)

Advanced System Design

Advanced System: XB5DD030/050 Connected Through Modbus RTU or TCP/IP

Example of an advanced system architecture:

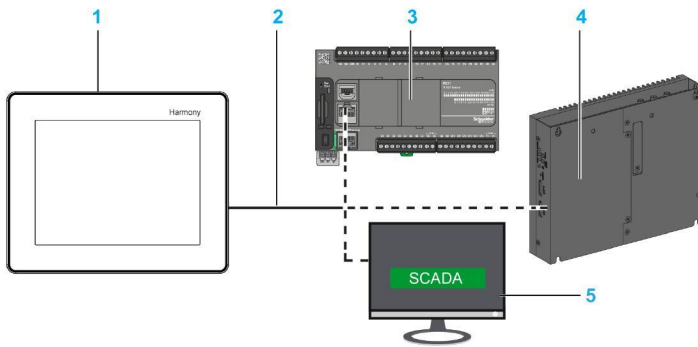

- 1 XB5DD030/050 unit
- 2 Cable for COM1 connection or Ethernet Connection
- 3 Controller
- 4 iPC
- 5 Supervision (for example SCADA)

Multi-Device Architecture

In advanced systems, as the Harmony Display is a Modbus slave, you can connect several Harmony displays to one Modbus Master:

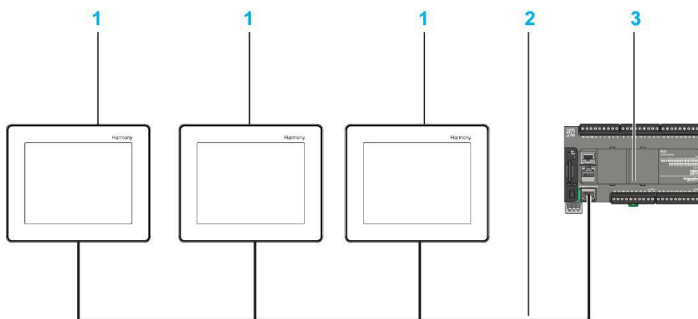

- 1 XB5DD030/050 units
- 2 Cable for Ethernet Connection
- 3 Controller

Commissioning

To commission the Advanced system, you have to:

- Write your program in accordance with the Harmony Display Memory mapping. (*see page 125*)
- Wire correctly the system (*see page 72*)
- Configure the Harmony Display application. (*see page 79*)

Chapter 2

XB5DD030/050

Overview

This chapter describes the XB5DD030/050 and connectable devices.

What Is in This Chapter?

This chapter contains the following topics:

Topic	Page
XB5DD030/050 of Harmony Displays	18
XB5DD030/050 Package Contents	21
Accessories	22
Parts Identification and Functions	23
Certifications and Standards	26

XB5DD030/050 of Harmony Displays

Introduction

The XB5DD030/050 is a panel display product that has an operating voltage of 24 Vdc.

The following table describes the XB5DD030/050 characteristics:

Part Number	Marking on Overlay	Screen Size	Screen (Pixel) Resolution	Mono/Color	Screen Technology	Serial Port	Ethernet Port
XB5DD030	Yes	8.9 cm (3.5 in.)	320 x 240 (QVGA)	65 K colors and LED's backlight	TFT	Yes	Yes
XB5DD050	Yes	14.48 cm (5.7 in.)	320 x 240 (QVGA)	65 K colors and LED's backlight	TFT	Yes	Yes

TFT: Thin-Film Transistor Technology.

Critical Systems, Detected Alarms and Handling Requirements

Critical detected alarm indicators and system functions require independent and redundant protection hardware and/or mechanical interlocks.

If the unit for any reason becomes inoperative (for example, an inoperative backlight) it may be difficult or impossible to identify a function. Functions that may present a hazard if not immediately executed, such as emergency stop, must be provided independently of the unit. The design of the control system must take into account an inoperative unit (backlight) and that the operator is unable to control the machine or respond to detected errors using the unit.

When the power is cycled, wait at least 10 seconds before restoring the power to the HMI unit. Switching the power OFF and ON quickly can damage the unit.

WARNING

LOSS OF CONTROL

- Consider the potential failure modes of control paths in the machine control system design, such as:
 - The possibility of backlight failure,
 - Unanticipated link transmission delays or failures,
 - The operator being unable to control the machine,
 - The operator making errors in the control of the machine.
- Provide a means to achieve a safe state during and after a path failure for critical control functions such as emergency stop and overtravel stop.
- Provide separate or redundant control paths for critical control functions.
- Test individually and thoroughly each implementation of the XB5DD030/050 for correct operation before service.

Failure to follow these instructions can result in death, serious injury, or equipment damage.

WARNING

UNINTENDED EQUIPMENT OPERATION

- Do not use the unit as the only means of control for critical system functions such as motor start/stop or power control.
- Do not use the unit as the only notification device for critical alarms, such as device overheating or overcurrent.

Failure to follow these instructions can result in death, serious injury, or equipment damage.

Handling the LCD Panel

The following characteristics are specific to the LCD unit and are considered normal behavior:

- LCD screen may show unevenness in the brightness of certain images or may appear different when seen from outside the specified viewing angle. Extended shadows, or cross-talk, may also appear on the sides of screen images.
- LCD screen pixels may contain black and white colored spots and color display may seem to have changed over time.
- When the same image is displayed on the screen for a long period, an after-image may appear when the image is changed. If this happens, turn off the unit, wait 10 seconds and then restart it.

NOTE: Do not display the same image for a long time, change the screen image periodically.

CAUTION

SERIOUS EYE AND SKIN INJURY

The liquid present in the LCD panel contains an irritant:

- Avoid direct skin contact with the liquid.
- Wear gloves when you handle a broken or leaking unit.
- Do not use sharp objects or tools in the vicinity of the LCD touch panel.
- Handle the LCD panel carefully to prevent puncture, bursting, or cracking of the panel material.

If the panel is damaged and any liquid comes in contact with your skin, immediately rinse the area with running water for at least 15 minutes.

If the liquid gets in your eyes, immediately rinse your eyes with running water for at least 15 minutes and consult a doctor.

Failure to follow these instructions can result in injury or equipment damage.

Using Touch Panel Correctly

WARNING

UNINTENDED EQUIPMENT OPERATION

- Operate the XB5DD030/050 touch panel with only one finger.
- Do not activate two or more points of the touch panel simultaneously.

Failure to follow these instructions can result in death, serious injury, or equipment damage.

Use only one finger to select an object on the touch panel.

If the touch panel receives pressure at two or more points at the same time, an unintended object could be selected.

XB5DD030/050 Package Contents

Package Contents

Verify all items listed here are present in your package:

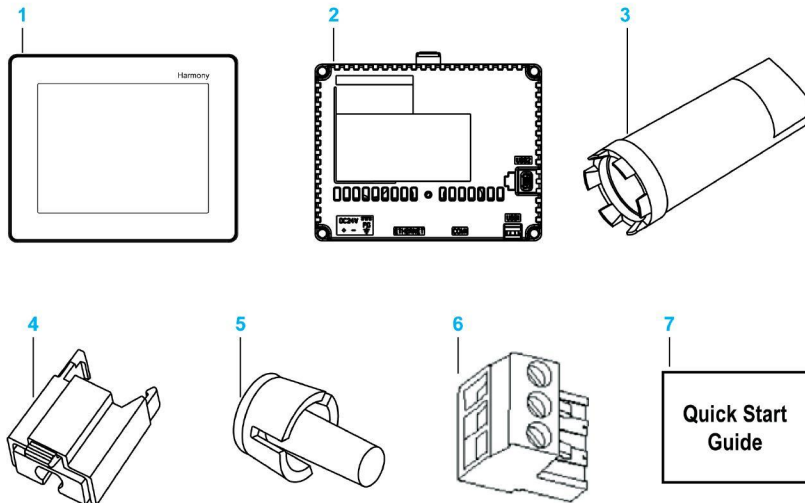

- 1 Display Module
- 2 Rear Module
- 3 Tightening Wrench
- 4 USB Standard Type A Cable Holder
- 5 Anti-rotation Tee
- 6 Terminal block
- 7 Quick Start Guide

Accessories

Optional Accessories

Product Number	Description
HMIZS61	Set of 5 Screen Protective Sheets for XB5DD030
HMIZSU62	Set of 5 Screen Protective Sheets for XB5DD050
HMIZSUKIT	Accessory Kit for XB5DD030/050, contains: <ul style="list-style-type: none"> ● USB standard Type A cable holder ● USB mini B cable holder ● Anti-rotation tee ● 2 Harmony Display adapters
ZB5AZ905	Tightening Wrench
ZB5AZ901	Kit of 10 display module fixing nuts
XBTZGPWS1	Set of 5 Power connectors

Communication Cables

Product Number	Description	
XBTZ9980	(2.5 m/8.20 ft)	Connects to Modicon M2**, M340
XBTZ9982	(10 m/32.8 ft)	

SD Card with TM221C16R Program

Product Number	Description
ZBSD01	SD card containing TM221C16R programs with appropriate memory table.

Parts Identification and Functions

Display Module

Front:

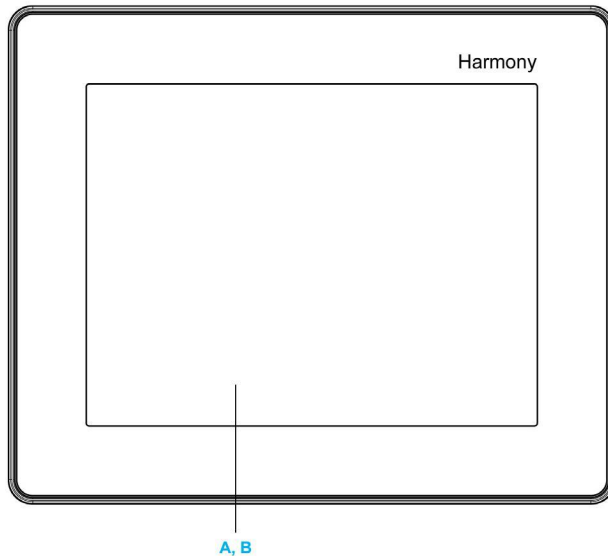

- A Display: displays user created screens and remote equipment variables.
- B Touch panel: performs screen change operations.

Rear:

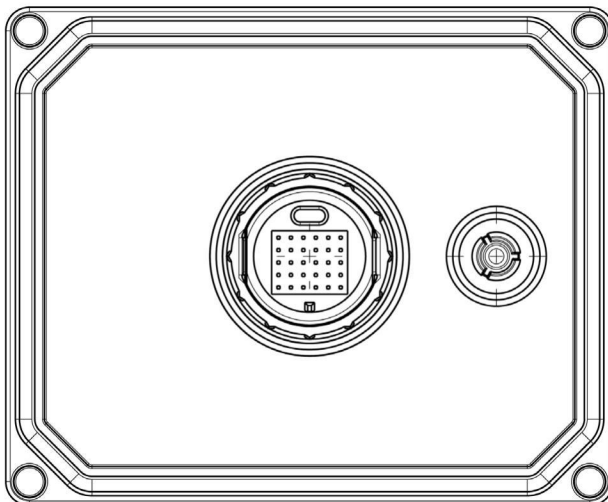

Rear Module

Front:

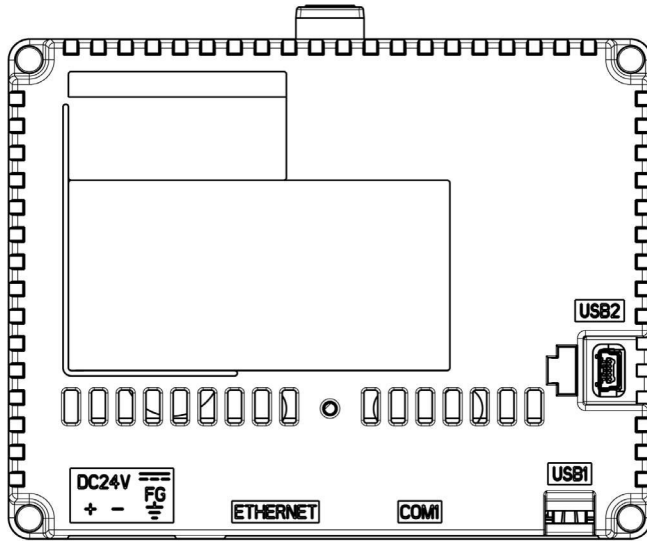

Rear:

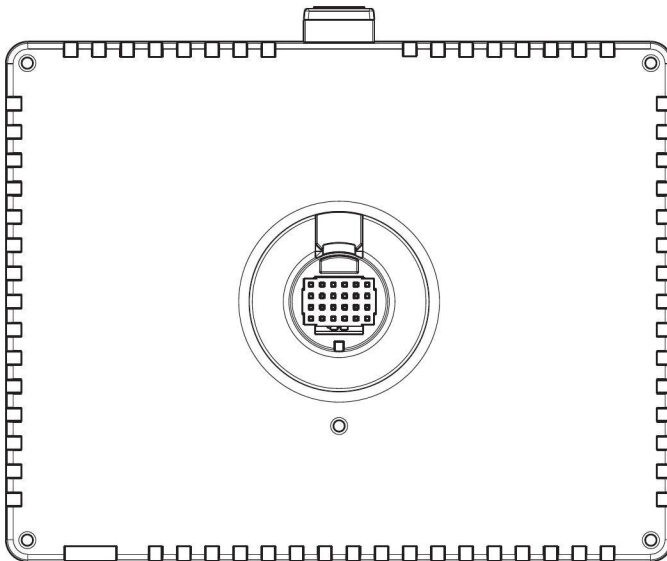

Connectors:

Bottom:

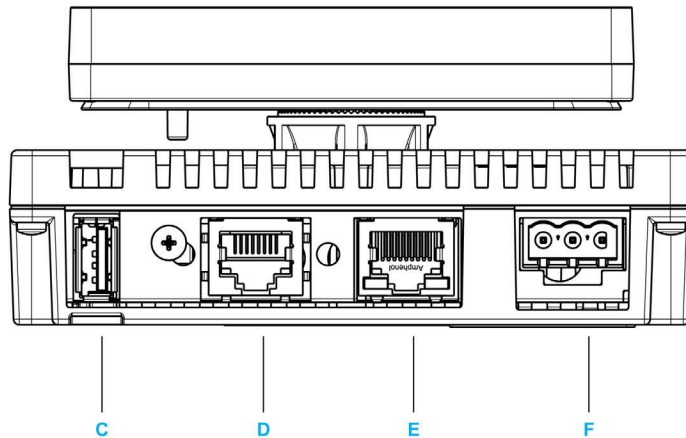

Side:

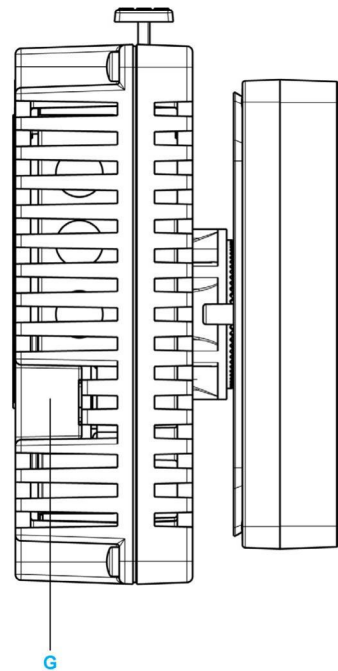

- C **USB1:** Standard A USB port connector: connects memory stick to the unit.
- D **COM1:** Serial Interface (8-pin RJ45): connects an RS-485 (serial) cable (from the host/PLC) to the unit.
- E **ETHERNET:** Ethernet Interface (LAN): connects an Ethernet cable (from the host/PLC) to the unit.
- F **Power input terminal block:** connects the power input and ground wires to the unit.
- G **USB2:** Mini-B USB port connector: not used.

Certifications and Standards

Introduction

Schneider Electric has developed an application and installed it in Magelis panel display:

Harmony Display	Magelis panel display
XB5DD030	HMISTU655W + embedded application
XB5DD050	HMISTU855W + embedded application

Schneider Electric submitted this product for independent testing and qualification by third-party listing agencies. These agencies have certified this product as meeting the following standards.

Agency Certifications

HMISTU655W and HMISTU855W are certified by the Underwriters Laboratory according to:

- UL 508 and CSA C22.2 n°142 for Industrial Control Equipment
- ANSI/ISA 12.12.01 and CSA C22.2 n°213 for Electrical Equipment for Use in Class I, Division 2 Hazardous Locations

ATEX certification by INERIS is ongoing, please refer to product label.

HMISTU655W and HMISTU855W are designed to comply to merchant navy bridge and deck requirements (Refer to the Schneider Electric website for installation guidelines).

For detailed information, contact your local distributor or see the catalog & marking on the product.

Hazardous Substances

HMISTU655W and HMISTU855W are designed for compliance with:

- WEEE, Directive 2002/96/EC
- RoHS, Directive 2011/65/EU
- RoHS China, Standard SJ/T 11363-2006

UL Conditions of Acceptability and Handling Cautions

HMISTU655W and HMISTU855W are suitable for use in hazardous locations in accordance with Class 1, Division 2 standards. All relevant local, state, and regional codes must be followed.

CE Markings

HMISTU655W and HMISTU855W are conforms to the necessary requirements of the following Directives for applying the CE label:

- 2006/95/EC Low Voltage Directive
- 2004/108/EC EMC Directive

This conformity is based on compliance with IEC61131-2.

WARNING

RISK OF EXPLOSION IN HAZARDOUS LOCATIONS

- Verify that the power, input and output (I/O) wiring are in accordance with Class I, Division 2 wiring methods.
- Do not substitute components that may impair compliance to Class I, Division 2.
- Do not connect or disconnect equipment unless power has been switched off or the area is known to be non-hazardous.
- Securely lock externally connected units and each interface before turning on the power supply.

Failure to follow these instructions can result in death, serious injury, or equipment damage.

WARNING

RISK OF EXPLOSION IN HAZARDOUS LOCATIONS

- Do not disconnect while circuit is live.
- Potential electrostatic charging hazard: wipe the front panel of the terminal with a damp cloth before turning ON.

Failure to follow these instructions can result in death, serious injury, or equipment damage.



Chapter 3

Specifications

Overview

This chapter presents the XB5DD030/050 specifications.

What Is in This Chapter?

This chapter contains the following sections:

Section	Topic	Page
3.1	General Specifications	30
3.2	Functional Specifications	32
3.3	Interface Specifications	35
3.4	Dimensions	38

Section 3.1

General Specifications

General Specifications

Electrical Specifications

The following table shows the electrical specifications of XB5DD030/050:

Part Number	Rated Input Voltage	Input Voltage Limits	Acceptable Voltage Drop	Power Consumption	In-Rush Current	Voltage endurance between power terminal and functional ground (FG)	Insulation Resistance between power terminal and FG
XB5DD030	24 Vdc	20.4 Vdc to 28.8 Vdc	≤ 10 ms	≤ 6.5 W	≤ 30 A	1000 Vac 20 mA for 1 minute	10 MΩ or higher at 500 Vdc
XB5DD050	24 Vdc	20.4 Vdc to 28.8 Vdc	≤ 7 ms	≤ 6.8 W	≤ 30 A	1000 Vac 20 mA for 1 minute	10 MΩ or higher at 500 Vdc

Environmental Specifications

The following table shows the environmental specifications of XB5DD030/050:

	Specification	XB5DD030	XB5DD050
Physical Environment	Ambient operating temperature (cabinet interior and panel face)	0...50 °C (32...122 °F)	0...50 °C (32...122 °F)
	Storage temperature	-20...+60 °C (-4 °F to 140 °F)	-20...+60 °C (-4 °F to 140 °F)
	Relative Humidity	85 % w/o condensation (Non-condensing, wet bulb temperature 39 °C (102.2 °F) or less)	85 % w/o condensation (Non-condensing, wet bulb temperature 39 °C (102.2 °F) or less)
	Air purity (dust)	≤ 0.1 mg/m ³ (10 ⁻⁷ oz/ft ³) (non-conductive levels)	≤ 0.1 mg/m ³ (10 ⁻⁷ oz/ft ³) (non-conductive levels)
	Corrosive gases	Free of corrosive gases	Free of corrosive gases
	Atmospheric pressure	800...1,114 hPa (2000 m (6,561 ft) or lower)	800...1,114 hPa (2000 m (6,561 ft) or lower)
Mechanical Environment	Vibration immunity (operating)	IEC 61131-2 1 gn 5...150 Hz (maximum 3.5 mm (0.13 in.))	IEC 61131-2 1 gn 5...150 Hz (maximum 3.5 mm (0.13 in.))
	Protection (front panel)	IP 65 - (IEC 60529)	IP 65 - (IEC 60529)
	Protection structure	Type 4X indoor, installed on a panel	Type 4X indoor, installed on a panel
	Protection (rear panel)	IP20 - (IEC 60529)	IP20 - (IEC 60529)
	Shock immunity (operating)	IEC 61131-2 15 gn 11 ms	IEC 61131-2 15 gn 11 ms
	Cooling method	Natural air circulation	Natural air circulation
	Weight	0.25 kg (0.55 lb.) or less (main unit only)	0.25 kg (0.55 lb.) or less (main unit only)
	Color	Front bezel: dark gray	Front bezel: dark gray
Material	PC/PBT	PC/PBT & PAA	
Electrical Environment	Noise immunity	Noise voltage: 1000 Vp-p Pulse width: 1 μs Rising time: 1 ns	Noise voltage: 1000 Vp-p Pulse width: 1 μs Rising time: 1 ns
	High Energy Surges	1 kV CM, 0.5 kV DM on DC power supply 1 kV CM on shielded cables	1 kV CM, 0.5 kV DM on DC power supply 1 kV CM on shielded cables
	Electrical fast transient burst	2 kV CM, 2 kV DM on DC power supply. 1 kV on shielded cables	2 kV CM, 2 kV DM on DC power supply. 1 kV on shielded cables
	Radiated radio frequency electromagnetic field	10 V/m / 80 MHz to 2.7 GHz Sinus amplitude modulated 80 % 1 kHz + Internal clock frequency	10 V/m / 80 MHz to 2.7 GHz Sinus amplitude modulated 80 % 1 kHz + Internal clock frequency
	Electrostatic Discharge Immunity	6 kV direct contact 8 kV air contact	6 kV direct contact 8 kV air contact
	Grounding	D type grounding (SG-FG connected)	D type grounding (SG-FG connected)
CM Common Mode DM Differential Mode			

Section 3.2

Functional Specifications

Overview

This section presents the XB5DD030/050 functional specifications of the display, memory and interfaces.

What Is in This Section?

This section contains the following topics:

Topic	Page
Display	33
Touch Panel	34

Display

Display Specifications

The following table shows the display specifications of the XB5DD030/050:

Items	XB5DD030	XB5DD050
Type	Color TFT LCD	
Resolution (pixels)	320 x 240 (QVGA)	
Active Display Area (W x H)	70.56 x 52.92 mm (2.78 x 2.08 in.)	115.2 x 86.4 mm (4.53 x 3.40 in.)
Colors	65536 colors	
Backlight	LED backlight:	
	Lifetime: 50000 hours before dimmed to 50% brightness. Ambient temperature = 25 °C (77 °F)	
	Non-exchangeable	
Brightness on LCD surface	White LED: 350 cd/m ² (33 cd/ft ²) maximum	
View angle	<ul style="list-style-type: none">● 60 °: left, right● 40 °: up● 60 °: down (Test condition: contrast ratio > 2)	<ul style="list-style-type: none">● 80 °: left, right● 70 °: up● 70 °: down (Test condition: contrast ratio > 2)

Touch Panel

Touch Panel

The following table shows the touch-panel specifications of XB5DD030/050:

Items	Specification
Type	Analog resistance film type (Metal Tab, Golden Plated)
Lifetime	1 million touches or more

Section 3.3

Interface Specifications

Overview

This section presents the interface specifications of the XB5DD030/050 units.

What Is in This Section?

This section contains the following topics:

Topic	Page
Interface Specifications	36
Specifications of Serial Interface COM1	37

Interface Specifications

Serial Interface COM1

The following table describes the serial interface COM1 of XB5DD030/050 unit:

Interface	Description
Serial interface COM1 RJ45	
Asynchronous Transmission	RS-485
Data Length	7 bits or 8 bits
Stop bit	1 bit or 2 bits
Parity	None, odd, or even
Data Transmission Speed	2,400...115,200 bps
Maximum Transmission Distance	1200 m (3,937 ft) at 100 kbps

USB1 Interface (USB Peripherals)

The following table describes the USB1 Interface of XB5DD030/050 unit:

Interface	Description	
HOST Interface		
Transmission Speed	High speed	480 Mbit/s
	Full speed	12 Mbit/s
	Low speed	1.5 Mbit/s
Maximum Current Supplied	250 mA	
Maximum Transmission Distance	5 m (16.40 ft) at 12 Mbit/s	
Connector	USB Type-A V2.0	

USB2 Interface

USB Mini B V2.0 type connector not used.

Ethernet Interface

The following table describes the LED colors and status:

LED	Contents
Green 1	Link state
Green 2	Activity

Specifications of Serial Interface COM1

Introduction

This interface is used to connect the XB5DD030/050 to remote equipment via an RS-485 cable as XBTZ9980 or XBTZ9982. The connector used is a RJ45-8 pin type connector.

When using a long PLC cable to connect the unit, a difference of electric potential can be observed between the cable and the unit, even if both are connected to ground.

The serial port is not isolated. The SG (signal ground) and the FG (functional ground) terminals are connected inside the unit.

NOTE: When setting up RS-485 communication, the cable diagram for some equipment may require polarization on the terminal side. This terminal does not require any special setting as it handles polarization automatically.

DANGER

ELECTRIC SHOCK

When using the SG terminal to connect an external device to the unit:

- Verify that a short-circuit loop is not created when you set up the system.
- Connect the #8 SG terminal to remote equipment when the host (PLC) unit is not isolated. Connect the #8 SG terminal to a known reliable ground connection to reduce the risk of damaging the RS-485 circuit.

Failure to follow these instructions will result in death or serious injury.

Serial Interface COM1

The following table describes the RJ45-8 pin connector on the XB5DD030/050 units:

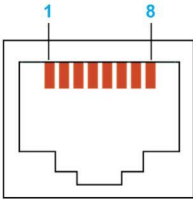
Pin Connection	Pin	Signal Name	Direction	Meaning
	1	Not connected	-	-
	2	Not connected	-	-
	3	Not connected	-	-
	4	D1	Output/Input	Transfer data (RS-485)
	5	D0	Output/Input	Transfer data (RS-485)
	6	Not connected	-	-
	7	Not connected	-	-
	8	SG	-	Signal Ground

Section 3.4

Dimensions

XB5DD030/050

Display Module XB5DD030

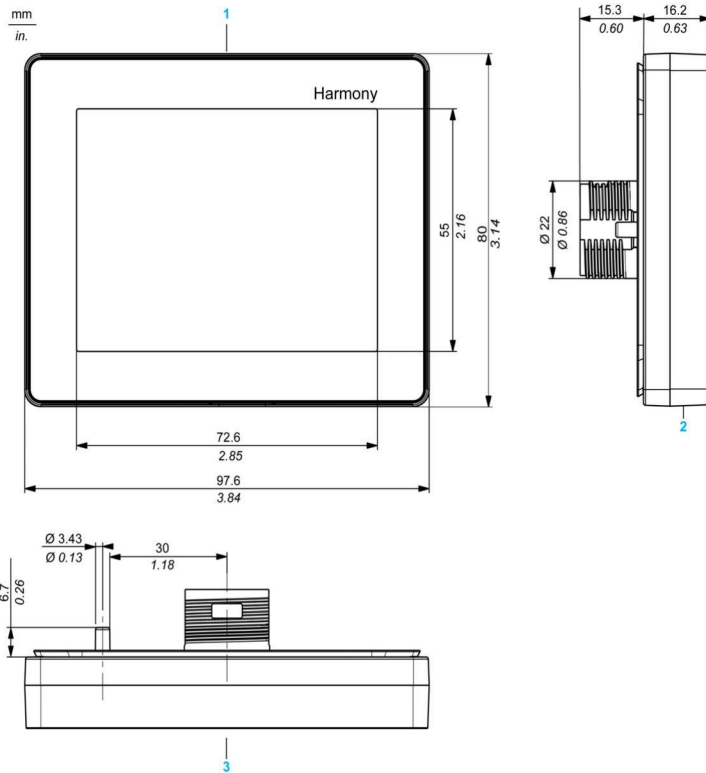

- 1 Front
- 2 Left Side
- 3 Top

Display Module XB5DD050

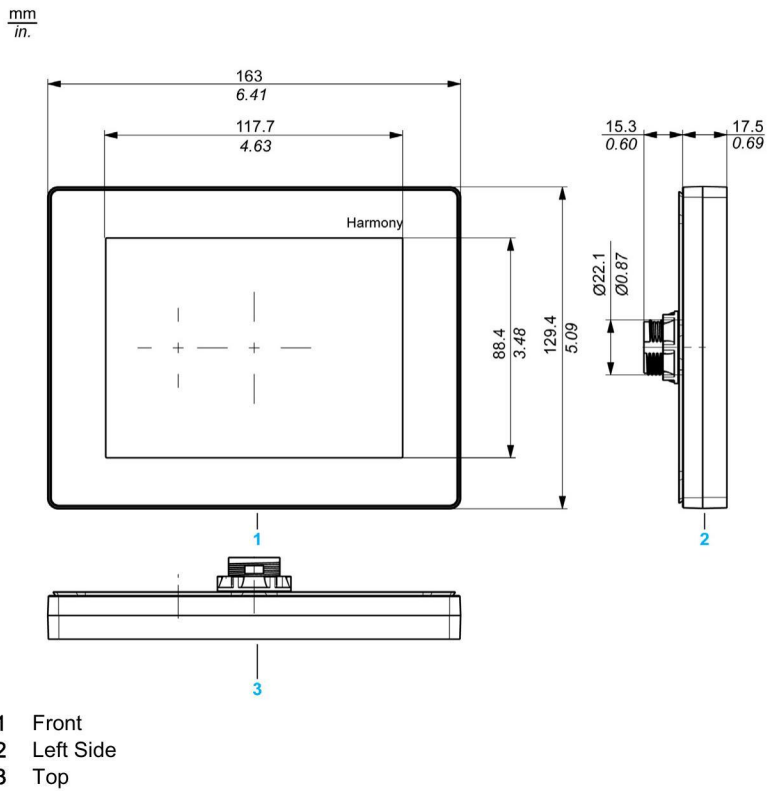

Rear Module XB5DD030/050

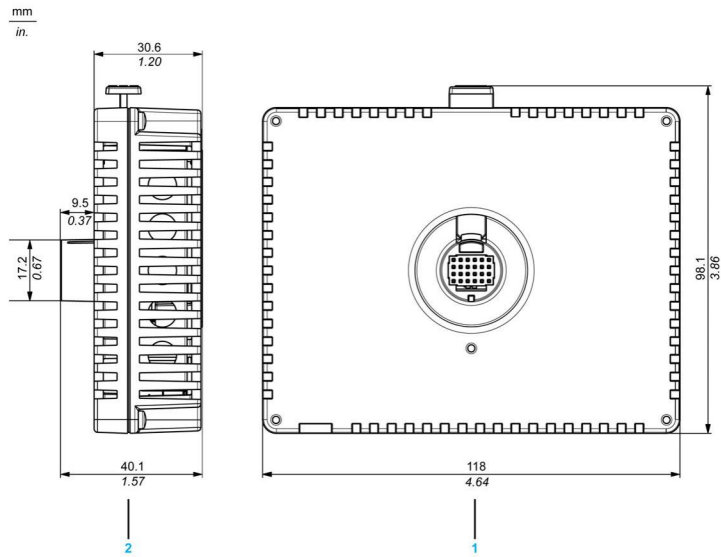

- 1 Front
- 2 Right Side

Display and Rear Modules XB5DD030

mm
in.

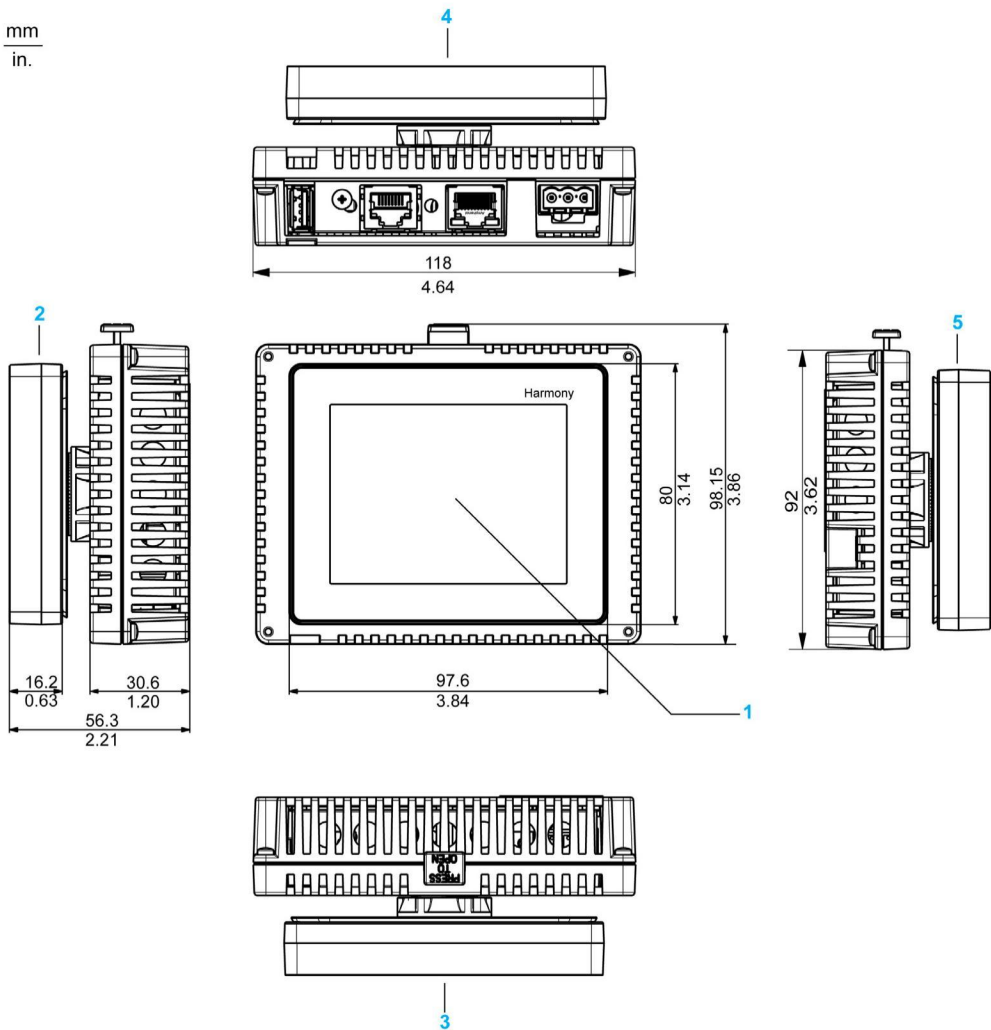

- 1 Front
- 2 Right side
- 3 Top
- 4 Bottom
- 5 Left side

Display and Rear Modules XB5DD050

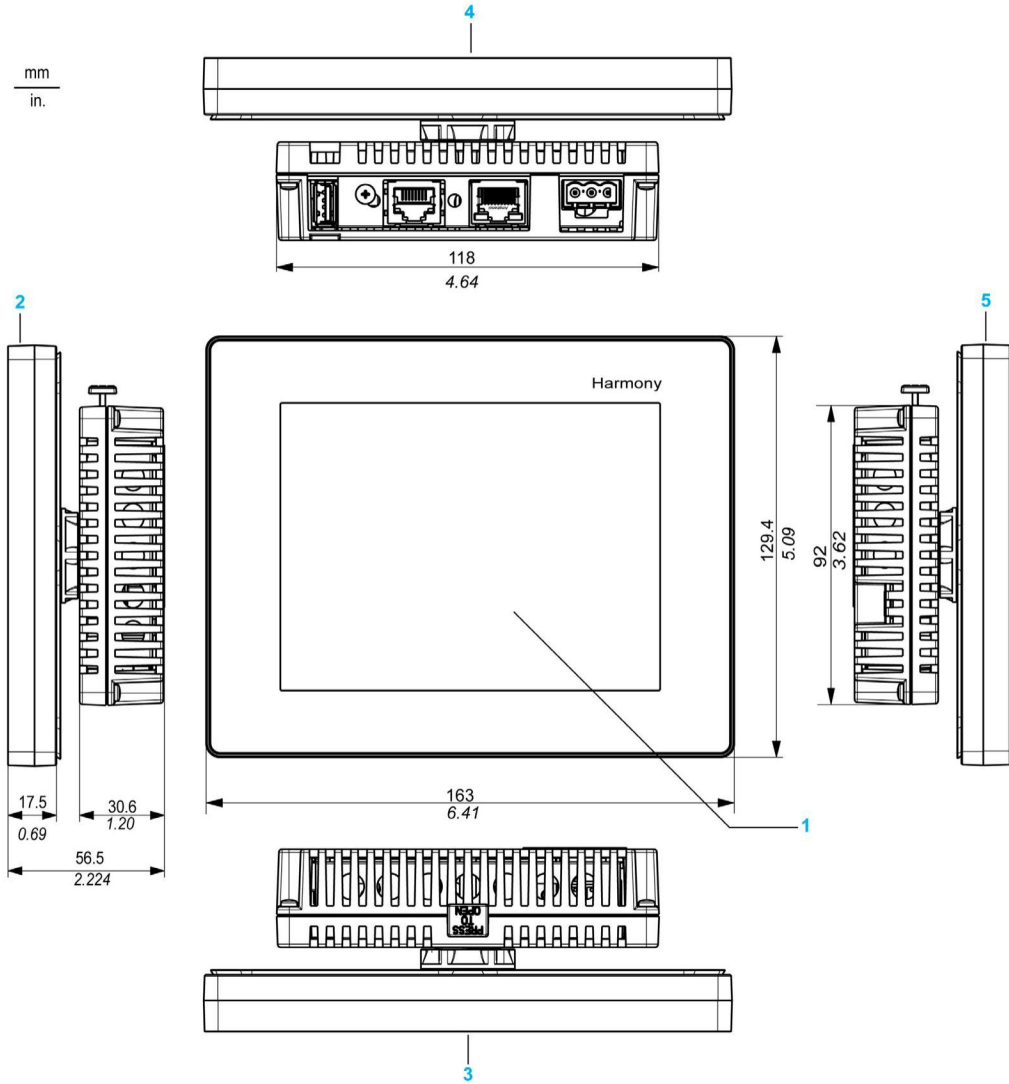

- 1 Front
- 2 Right side
- 3 Top
- 4 Bottom
- 5 Left side

Chapter 4

Installation and Wiring

Overview

This chapter describes the installation procedures and the wiring principles for XB5DD030/050.

What Is in This Chapter?

This chapter contains the following sections:

Section	Topic	Page
4.1	Installation	44
4.2	Wiring Principles	54
4.3	USB Ports	62
4.4	Serial Communication Port	63
4.5	Ethernet Cable Connector	64
4.6	System Wiring	65
4.7	SD Card Management	73

Section 4.1

Installation

Overview

This section describes the installation Procedures for XB5DD030/050.

What Is in This Section?

This section contains the following topics:

Topic	Page
Harmony Display Cut-Out Dimensions and Installation	45
Installation Procedures	49

Harmony Display Cut-Out Dimensions and Installation

Inserting a XB5DD030/050 Without an Anti-Rotation Tee

Create a panel cut-out and insert the display module of the unit into the panel from the front. The following illustration shows the panel cut-out for a XB5DD030/050 unit without a tee:

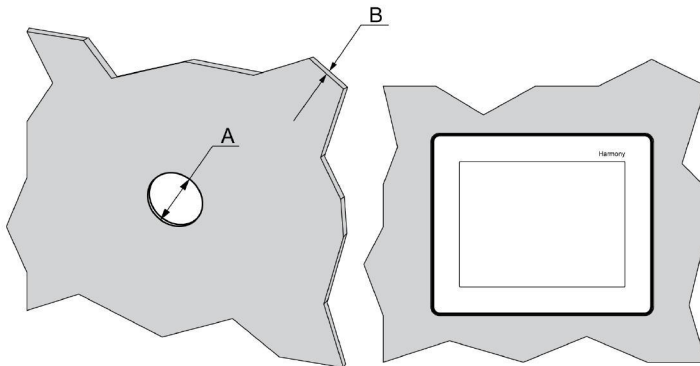

Dimensions

Unit	A (mm)	A (in.)	B (1)	B (2)
XB5DD030/050	+0 22.50 -0.30	+0 0.88 -0.01	1.5...6 mm (0.06...0.23 in.)	3...6 mm (0.11...0.23 in.)

(1) Steel sheet
(2) Glass fiber reinforced plastics (minimum GF30)

NOTE: Without the tee option, the rotating torque that can be supported by the display module is 2.5 Nm (22.12 in-lb).

Inserting a XB5DD030/050 with an Anti-Rotation Tee

Create a panel cut-out and insert the display module of the unit into the panel from the front. The following illustration shows the panel cut-out for a XB5DD030/050 unit using a tee:

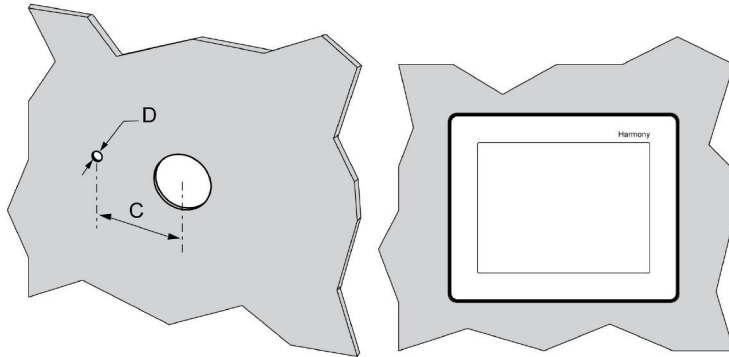

Dimensions

Unit	C (mm)	C (in.)	D (mm)	D (in.)
XB5DD030/050	+0	+0	+0	+0
	30.00	1.18	4.00	0.15
	-0.20	-0.007	-0.20	-0.007

NOTE: With the tee option, the rotating torque that can be supported by the display module is 6 Nm (53.10 in-lb).

Illustration

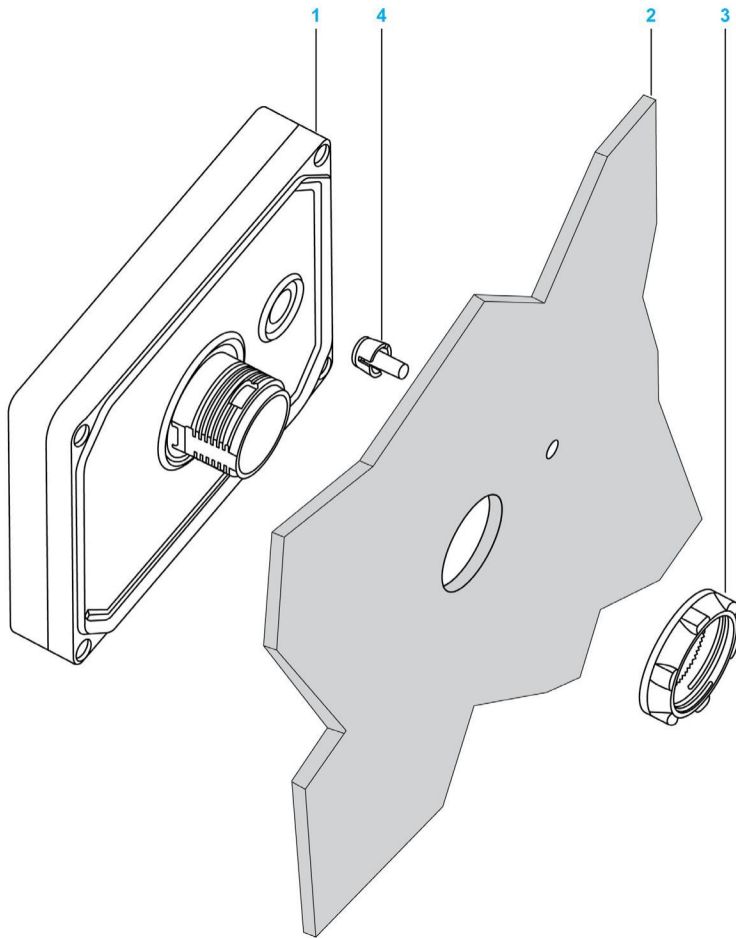

- 1 Display module
- 2 Support
- 3 Nut
- 4 Tee

Harmony Display Adaptor

The Harmony Display Adaptor, supplied in the accessory kit **HMIZSUKIT** (*see page 22*), allows mounting the product on a:

- Metallic support with a thickness between 1 and 1.5 mm (0.039 and 0.059 in.)
- Plastic support with a thickness between 1 and 3 mm (0.039 and 0.118 in.)
- Glass fiber reinforced plastic with a thickness between 2 and 3 mm (0.078 and 0.118 in.)

The following illustration shows the assembly with the panel adaptor:

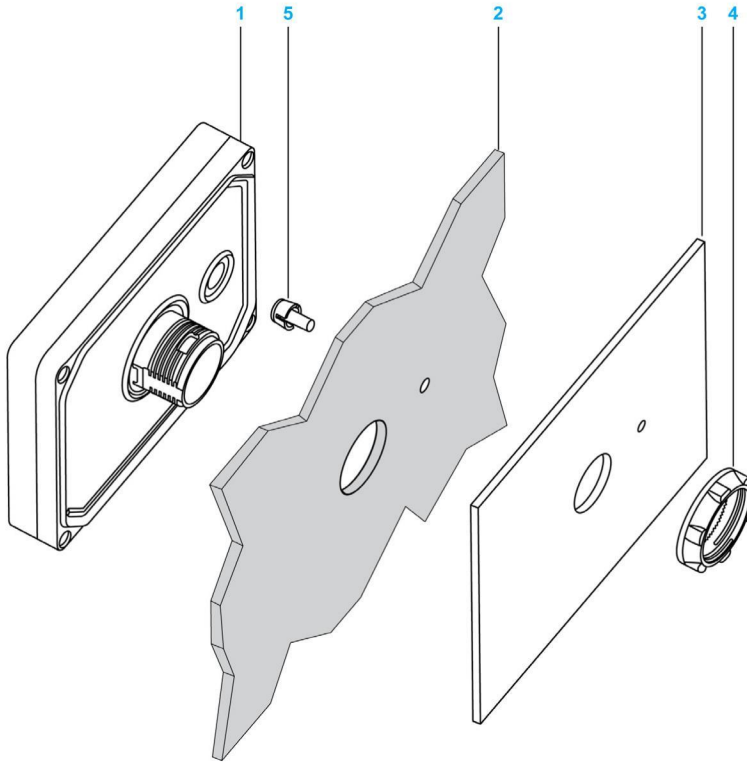

- 1 Display module
- 2 Support
- 3 Harmony Display adaptor
- 4 Nut
- 5 Tee

Installation Procedures

Harmony Display Setup Procedure

Mount the unit in an enclosure that provides a clean, dry, robust, and controlled environment (IP65 enclosure or UL50 4x if indoors) (*see page 31*).

Before installing the XB5DD030/050, verify that:

- The gasket is flat and not damaged.
- The installation panel or cabinet surface is flat (planarity tolerance: 0.5 mm (0.019 in.)), in good condition and has no jagged edges. Metal reinforcing strips may be attached to the inside of the panel, near the panel cut-out, to increase the rigidity.
- The panel must be designed to avoid any induced vibration resonance on the rear module exceeding a punctual factor of 10 and to avoid any induced permanent vibration resonance. To reduce the resonance, use the panel adaptor accessory.
- The ambient operating temperature and the ambient humidity are within their specified ranges (*see page 31*).
- The heat from surrounding equipment does not cause the unit to exceed its specified operating temperature (*see page 31*).
- The panel face is not inclined more than 30° when installing the unit in a slanted panel:

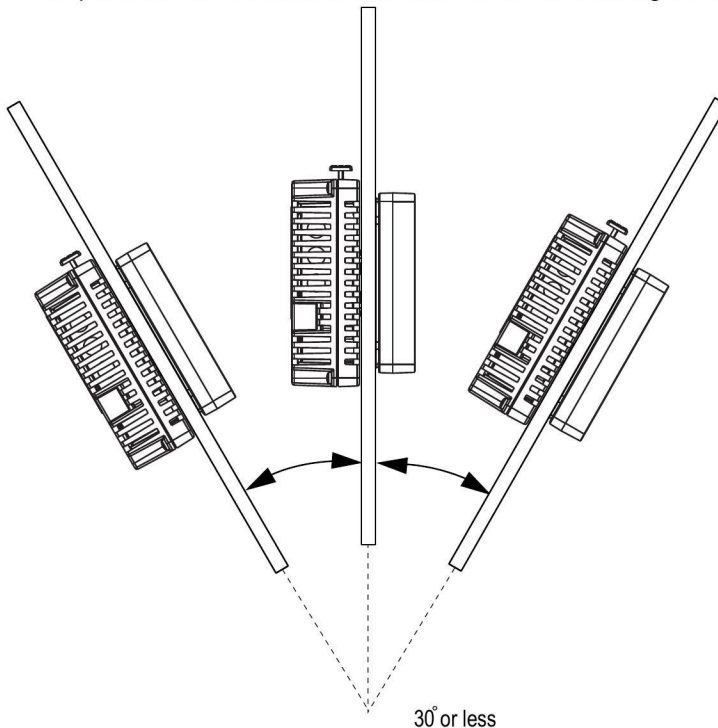

- The power plug is positioned vertically when the unit is vertically installed.
- The unit is at least 100 mm (3.94 in.) away from adjacent structures and other equipment for easier maintenance, operation, and improved ventilation:

$\frac{\text{mm}}{\text{in.}}$

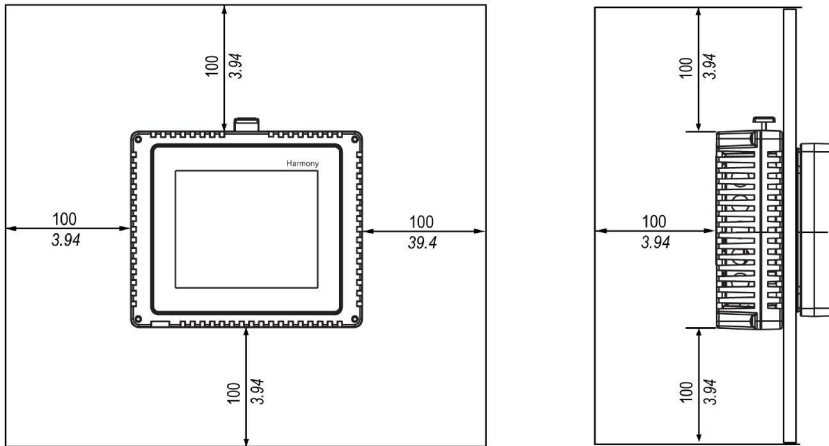

Step	Action
1	Place the unit on a clean and level surface with the display panel facing downward.
2	<p>The support thickness depends on the material:</p> <ul style="list-style-type: none"> • Metallic: between 1.5 and 6 mm (0.059 and 0.236 in.) • Plastic: between 3 and 6 mm (0.118 and 0.236 in.) <p>If the thickness is between 1 and 1.5 mm (0.039 and 0.059 in.) for metallic support or 1 and 3 mm (0.039 and 0.118 in.) for plastic, use the panel adaptor supplied in accessory kit HMIZSUKIT (see page 22).</p>
3	Create the correct sized holes required to install the unit, using the Harmony Display Cut-out Dimension and Installation (see page 45).

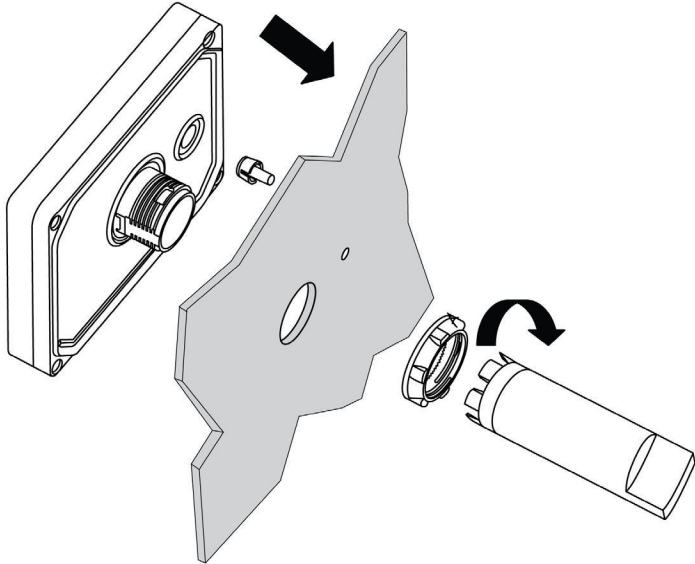
Step	Action
4	<p data-bbox="358 201 960 227">Insert the display module (with Tee, if used) into the panel hole:</p>  <p data-bbox="358 855 1201 900">Screw the nut with the tightening wrench with a torque between 1.2 and 2 Nm (10.62 and 17.70 in-lb.).</p>

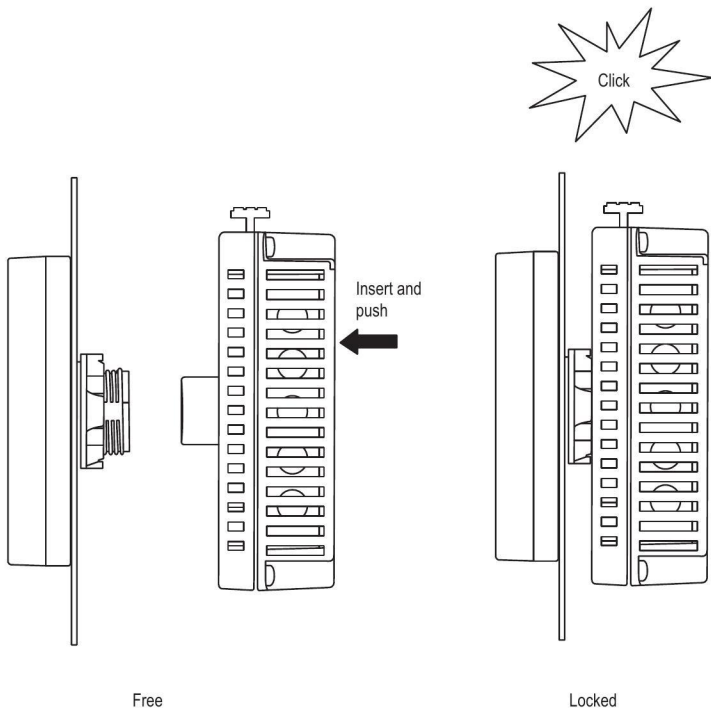
Step	Action
5	<p data-bbox="319 193 850 230">Insert and push the rear module until it locks into place:</p>  <p data-bbox="452 922 493 947">Free</p> <p data-bbox="891 922 946 947">Locked</p>

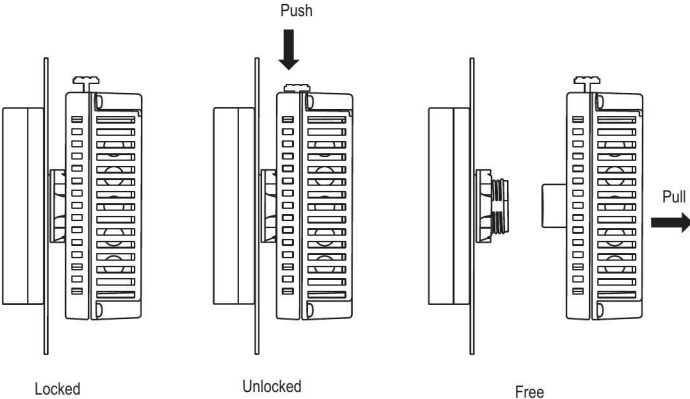
Step	Action
6	<p>To remove the rear module, push the yellow button to unlock it, then pull out the rear module:</p>  <p>The diagram illustrates the removal process in three stages: <ul style="list-style-type: none"> Locked: The rear module is fully inserted into the rack. Unlocked: A yellow button on the side of the module is pushed down, as indicated by a downward arrow labeled "Push". Free: The module is pulled out of the rack, as indicated by a rightward arrow labeled "Pull". </p>

⚠ WARNING

UNINTENDED MACHINE OPERATION

- Do not attach or detach the front display module while the back module is connected to the power.
- Ensure that the front module is securely attached before applying power to the back module.

Failure to follow these instructions can result in death, serious injury, or equipment damage.

Section 4.2

Wiring Principles

Overview

This section presents XB5DD030/050 wiring principles.

What Is in This Section?

This section contains the following topics:

Topic	Page
Connecting the Power Cord	55
Connecting the Power Supply	58
Grounding	60

Connecting the Power Cord

Introduction

Follow these instructions when supplying power to the unit:

- When the functional ground (FG) terminal is connected, verify that the wire is grounded. Not grounding the unit can result in excessive Electromagnetic Interference (EMI). Grounding is required to meet EMC level immunity.
- The shield ground (SG) and FG terminals are connected internally in the unit.
- Remove power before wiring to the power terminals of the unit.
- The unit uses only 24 Vdc power. Using any other level of power can damage both the power supply and the unit.
- Since the unit is not equipped with a power switch, connect a power switch to the unit's power supply.

Power Cord Preparation

Before using your power cord:

- Verify that the ground wire is the same gauge or heavier than the power wires.
- Do not use aluminum wires for the power cord for power supply.
- If the conductor end (individual) wires are not twisted correctly, the end wires may either short loop to each other or against an electrode. To avoid this, use D25CE/AZ5CE cable ends.
- Use wires that are 0.2 to 2.5 mm² (24...12 AWG) for the power cord, and twist the wire ends before attaching the terminals.
- The conductor type is solid or stranded wire.
- To reduce electromagnetic noise, make the power cord as short as possible.

Power Plug Illustration

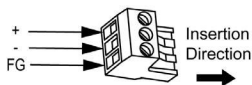

Connection	Wire
+	24 V
-	0 V
FG	Grounded terminal connected to the unit chassis

How to Connect the Power Cord

The following table explains how to connect the power plug:

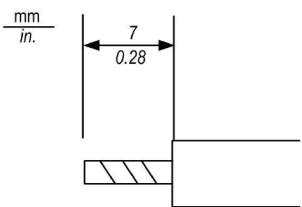
Step	Action
1	Remove the power cord from the power supply.
2	Remove the power plug from the unit.
3	Remove 7 mm (0.28 in.) of the vinyl cover of each of the power cord wires. 
4	If using stranded wire, twist the ends. Tinning the ends with solder reduces the risk of fraying and enhances electrical transfer.
5	Connect the wires to the power plug by using a flat-blade screwdriver (Size 0.6 x 3.5).
6	Torque the mounting screws: 0.5 to 0.6 Nm (4.4 to 5.2 lb-in).
7	Replace the power plug to the power connector.

NOTE:

- Do not solder the wire directly to the power receptable pin.
- The power supply cord must meet the specification shown above. Twist the power cords together, up to the power plug, for EMC cancelation. (See illustration as shown below).

Power Connection

The following illustration displays a connection of the power cord:

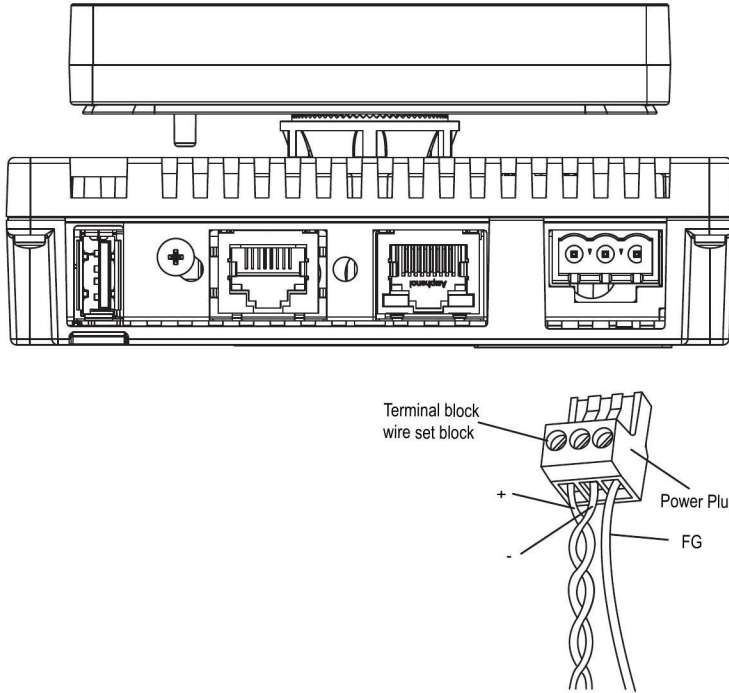

Connecting the Power Supply

Precautions

- Connect the power cord to the power connector on the side of the unit using the power plug.
- Use a regulated power supply with a Class 2 power supply between the line and the ground.
- Do not bundle the power supply cord with, or keep close to, main circuit lines (high voltage, high current), or input/output signal lines.
- Connect a lightning surge absorber to handle power surges.

Excessive stress on the power connection or attempting to install a unit with the power cables connected may disconnect or cause damage to the power connections. This can cause short circuits, fire, or unintended equipment operation.

WARNING

SHORT-CIRCUITS, FIRE, OR UNINTENDED EQUIPMENT OPERATION

- Securely attach power cables to the panel or cabinet.
- Use the designated torque to tighten the unit terminal block screws.
- Install and fasten unit on installation panel or cabinet prior to connecting Power Supply and Communication lines.

Failure to follow these instructions can result in death, serious injury, or equipment damage.

Power Supply Connections

For ease of maintenance, use the following optional connection diagram to set up your power supply connections.

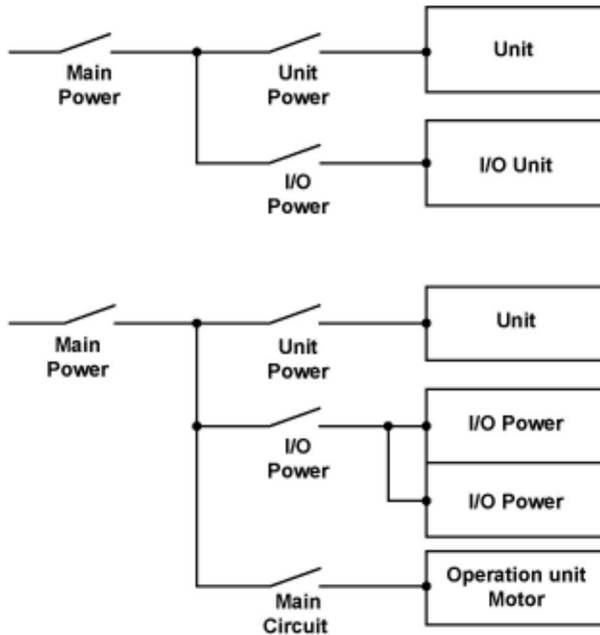

NOTE:

- Ground the surge absorber (E1) separately from the unit (E2).
- Select a surge absorber that has a maximum circuit voltage greater than the peak voltage of the power supply.

The following diagram displays a lightning surge absorber connection:

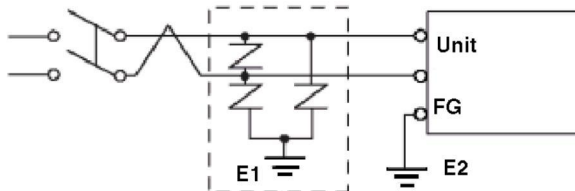

Grounding

Introduction

Take the following precautions for grounding the unit.

Exclusive Grounding

Connect the functional ground (FG) terminal on the power plug to an exclusive ground.

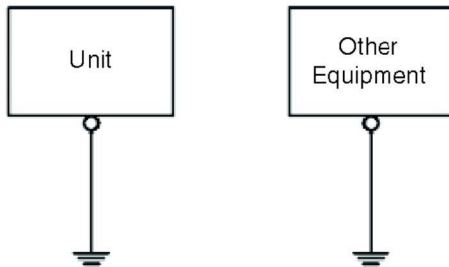

Grounding Procedure

Step	Action
1	Check that the grounding resistance is less than 100 Ω .
2	Create the connection point as close to the unit as possible, and make the wire as short as possible. When using a long grounding wire, replace the thin wire with a thicker wire, and place it in a duct.

Common Grounding

Precautions:

Electromagnetic Interference (EMI) can be created if the devices are improperly grounded. Electromagnetic Interference (EMI) can cause loss of communication.

Do not use common grounding, except for the authorized configuration described below.

If exclusive grounding is not possible, use a common connection point.

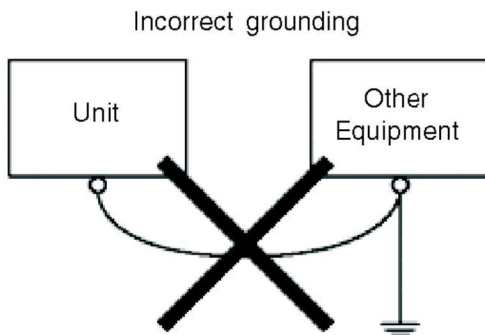
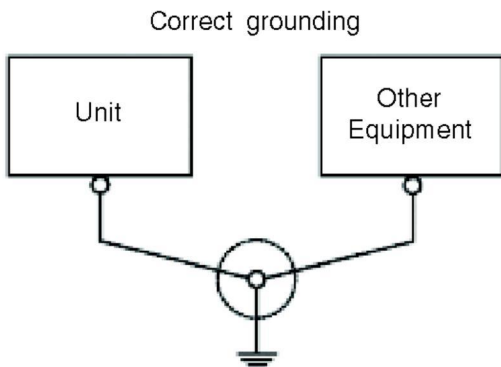

Section 4.3

USB Ports

USB Ports Overview

Standard A USB Port (USB1)

The USB port (USB1) is dedicated to load/save the configuration of the Harmony Display.

For more details, refer to Settings Pages (*see page 83*).

Mini-B USB Port (USB2)

The Mini-B USB port (USB2) is reserved for Schneider Electric use.

Section 4.4

Serial Communication Port

Serial Communication Port

Introduction

The XB5DD030/050 comes equipped with a Serial interface (8-pin RJ45).

Serial Communication Connector (COM1)

The following illustration displays the location of the RJ45 serial communication connector:

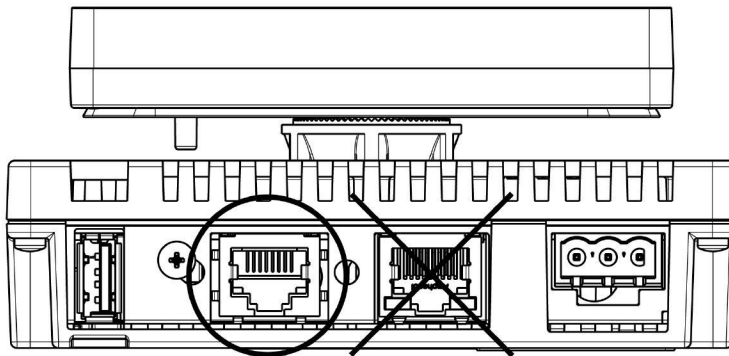

Do not confuse the RJ45 Ethernet connector with the RJ45 COM1 serial port.

NOTE: Networks must be installed by a trained and qualified person.

Section 4.5

Ethernet Cable Connector

Presentation

Introduction

The XB5DD030/050 comes equipped with an IEEE802.3 compliant Ethernet interface that transmits and receives data at 10 Mbit/s or 100 Mbit/s.

Ethernet Cable Connector

The following illustration displays the location of the RJ45 Ethernet cable connector:

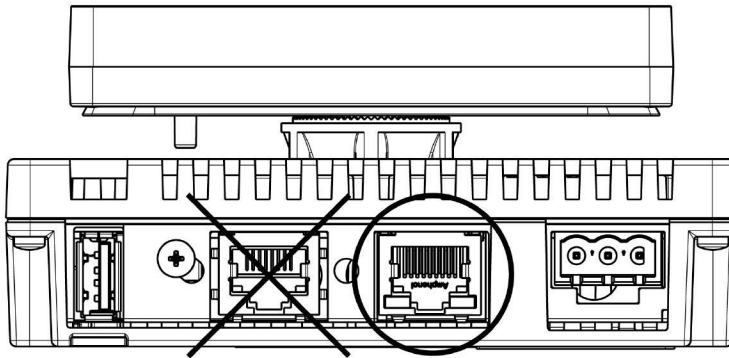

Do not confuse the RJ45 Ethernet connector with the RJ45 COM1 serial port.

NOTE: Ethernet networks must be installed by a trained and qualified person.

1:1 connections must be made with a hub or a switch. It is possible to use the 1:1 connection with a cross cable depending on the connected PCs and network cards.

Section 4.6 System Wiring

What Is in This Section?

This section contains the following topics:

Topic	Page
Standard System	66
Option System Design	68
Advanced System Design	72

Standard System

Standard System Wiring

You have to connect the input/output of the TM221C16R:

TM221	Harmony Display screens	Description	TM221		
Inputs		Display functions	Actions on outputs		
AN0	Analog 1		Controls a digital output (depending on thresholds of the analog input).	Q0	
AN1	Analog 2			Q1	
-	Analog 3			-	
-	Analog 4			-	
-	Cam switch		Sets the cam switch position.	Controls up to 5 digital outputs (depending on cam switch position).	Q2...Q6
I0...I3	Digital inputs 1...4		Displays digital inputs as pilot lights and texts, counters, or hour-counters.	-	
I4...I7	Digital inputs 5...8			-	

Pay attention on connecting the XBTZ9980 or XBTZ9982 serial cable from:

- TM221C16R: Serial line port 1 / RJ45 connector
- Harmony Display: COM1 connector (*see page 63*)

For more details on TM221C16R wiring, refer to the related instruction sheet (*see page 10*).

4...20 mA Wiring

In standard and option system, the analog inputs of TM221C16R are 0...10 V only. To transform one in 4...20 mA, you have to connect a 500 ohm resistor in parallel of the analog input:

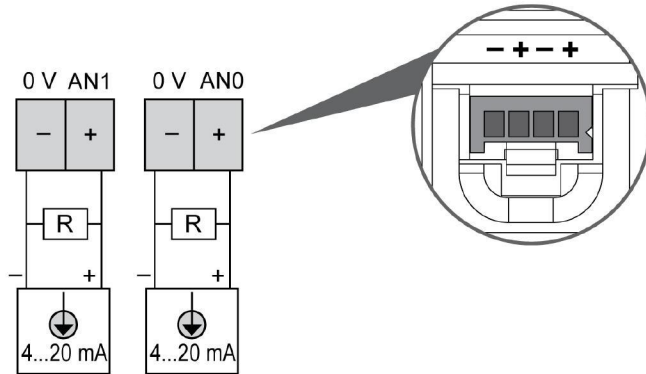



Wiring Example

Refer to standard and option System wiring example ([see page 71](#)).

Option System Design

Option System with Optional Analog Inputs Wiring

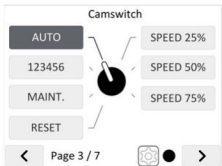
You have to connect the input/output of the TM221C16R+optional analog inputs cartridge (TMC2TI2 or TMC2AI2):

TM221	Harmony Display screens	Description	TM221		
Inputs		Display functions	Actions on outputs		
AN0	Analog 1		Controls a digital output (depending on thresholds of the analog input).		
AN1	Analog 2			Q0	
TMC2•I2 AI0	Analog 3			Q1	
TMC2•I2 AI1	Analog 4			-	
-	Cam switch		Sets the cam switch position.	Controls up to 5 digital outputs (depending on cam switch position).	Q2...Q6
IO...I3	Digital inputs 1...4		-	-	
I4...I7	Digital inputs 5...8		-	-	

NOTE: By exception, in order to be able to manage relay threshold in temperature applications with TMC2TI2 cartridge option, the threshold relays 1 and 2 (Q0 and Q1) are automatically switched to Analog value 3 and Analog value 4.

Pay attention on connecting the XBTZ9980 or XBTZ9982 serial cable from:



- TM221C16R: Serial line port 1 / RJ45 connector
- Harmony Display: COM1 connector (*see page 63*)

For more details on TM221C16R wiring, refer to the related instruction sheet (*see page 10*).

For more details on TMC2 cartridge wiring, refer to the related instruction sheet (*see page 10*).

Option System with Optional Analog Outputs Wiring

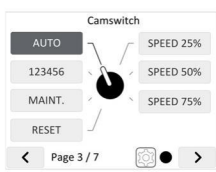
You have to connect the input/output of the TM221C16R+optional analog outputs cartridge (TMC2AQ2V or TMC2AQ2C):

TM221	Harmony Display screens	Description	TM221																																																																										
Inputs		Display functions	Actions on outputs																																																																										
AN0	Analog 1		Controls a digital output (depending on thresholds of the analog input).	Q0																																																																									
AN1	Analog 2		Q1																																																																										
-	Analog 3		Controls up to 5 digital outputs (depending on cam switch position).	TMC2AQ2•AO0																																																																									
-	Analog 4		TMC2AQ2•AO1																																																																										
-	Cam switch	 <table border="1" data-bbox="857 691 1067 850"> <thead> <tr> <th>Back</th> <th colspan="7">CamSwitch</th> <th>Next</th> </tr> <tr> <th>Pos/Relays</th> <th>R3</th> <th>R4</th> <th>R5</th> <th>R6</th> <th>R7</th> <th>R8</th> <th>R9</th> </tr> </thead> <tbody> <tr> <td>1 Pos1</td> <td>●</td> <td>●</td> <td>●</td> <td>●</td> <td>●</td> <td>●</td> <td>●</td> </tr> <tr> <td>2 Pos2</td> <td>●</td> <td>●</td> <td>●</td> <td>●</td> <td>●</td> <td>●</td> <td>●</td> </tr> <tr> <td>3 Pos3</td> <td>●</td> <td>●</td> <td>●</td> <td>●</td> <td>●</td> <td>●</td> <td>●</td> </tr> <tr> <td>4 Pos4</td> <td>●</td> <td>●</td> <td>●</td> <td>●</td> <td>●</td> <td>●</td> <td>●</td> </tr> <tr> <td>5 Pos5</td> <td>●</td> <td>●</td> <td>●</td> <td>●</td> <td>●</td> <td>●</td> <td>●</td> </tr> <tr> <td>6 Pos6</td> <td>●</td> <td>●</td> <td>●</td> <td>●</td> <td>●</td> <td>●</td> <td>●</td> </tr> <tr> <td>7 Pos7</td> <td>●</td> <td>●</td> <td>●</td> <td>●</td> <td>●</td> <td>●</td> <td>●</td> </tr> </tbody> </table>	Back	CamSwitch							Next	Pos/Relays	R3	R4	R5	R6	R7	R8	R9	1 Pos1	●	●	●	●	●	●	●	2 Pos2	●	●	●	●	●	●	●	3 Pos3	●	●	●	●	●	●	●	4 Pos4	●	●	●	●	●	●	●	5 Pos5	●	●	●	●	●	●	●	6 Pos6	●	●	●	●	●	●	●	7 Pos7	●	●	●	●	●	●	●		Q2...Q6
Back	CamSwitch							Next																																																																					
Pos/Relays	R3	R4	R5	R6	R7	R8	R9																																																																						
1 Pos1	●	●	●	●	●	●	●																																																																						
2 Pos2	●	●	●	●	●	●	●																																																																						
3 Pos3	●	●	●	●	●	●	●																																																																						
4 Pos4	●	●	●	●	●	●	●																																																																						
5 Pos5	●	●	●	●	●	●	●																																																																						
6 Pos6	●	●	●	●	●	●	●																																																																						
7 Pos7	●	●	●	●	●	●	●																																																																						
10...13	Digital inputs 1...4		-	-																																																																									
14...17	Digital inputs 5...8		-	-																																																																									

Pay attention on connecting the XBTZ9980 or XBTZ9982 serial cable from:

- TM221C16R: Serial line port 1 / RJ45 connector
- Harmony Display: COM1 connector (*see page 63*)

For more details on TM221C16R wiring, refer to the related instruction sheet (*see page 10*).

For more details on TMC2 cartridge wiring, refer to the related instruction sheet (*see page 10*).

4...20 mA Wiring

In standard and option system, the analog inputs of TM221C16R are 0...10 V only. To transform one in 4...20 mA, you have to connect a 500 ohm resistor in parallel of the analog input:

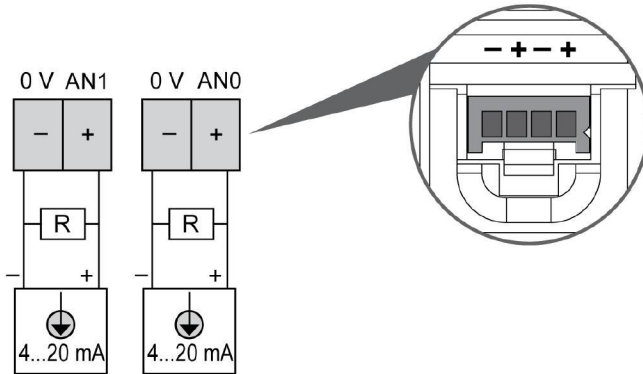

Wiring Example

Standard and option wiring example:

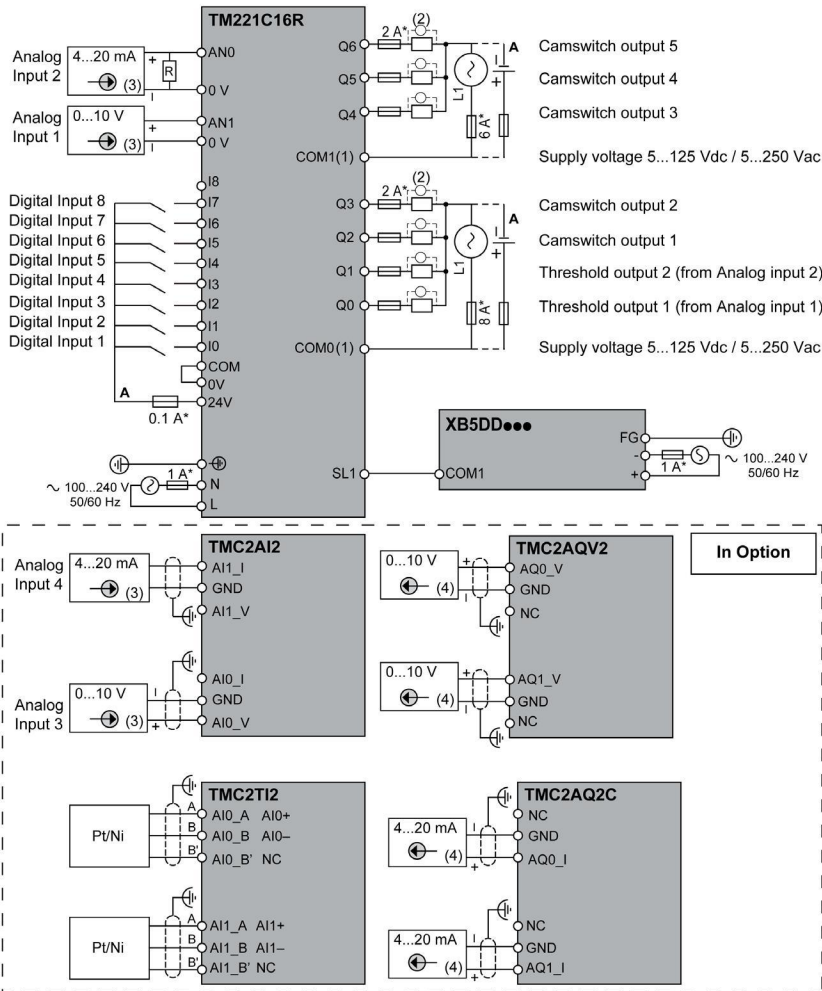

- (*) Type T fuse
- (1) The COM0 and COM1 terminals are **not** connected internally
- (2) Protection for inductive load
- (3) Current/Voltage analog output device
- (4) Current/Voltage analog input device
- NC No Connection
- R 500 ohm

Advanced System Design

Advanced System: XB5DD030/050 Connected Through Modbus RTU or TCP/IP

If you connect the XB5DD030/050 to any controller or PC with supervision, you have to make your own program to control the input/output of the XB5DD030/050. To do this, you must follow the XB5DD030/050 Memory mapping (*see page 125*).

Section 4.7

SD Card Management

SD Card Management

Overview

Standard and Option system is a ready-to-use system.

No need to write program in XB5DD030/050 neither in TM221C16R. To make Standard or Option system running, you have to download an existing TM221C16R program from the ZBSD01 SD card inside the TM221C16R.

TM221C16R Program

The following procedure describes how to download the program stored in the ZBSD01 SD card into your TM221C16R controller:

Step	Action
1	Prepare the ZBSD01 SD card.
2	Remove power from the controller.
3	Insert the SD card into the controller.
4	Restore power to the controller. Result: The operation is in progress. NOTE: The SD LED is turned on during the operation.
5	Wait until the end of the operation (until the SD LED is off or flashing). If an error is detected, the SD and ERR LEDs flash and the detected error is logged in <code>Script.log</code> file.
6	Remove the SD card to restart the controller.

NOTE: Downloading a program to the controller first removes the existing program from controller memory, regardless of any user access-rights that may be enabled in the target controller.

TM221C16R Program Management

The ZBSD01 SD card contains several programs:

- 1 for Standard system (program by default)
- 17 for Option system depending on the installed TMC2 cartridge.

Manage the program file to be downloaded in the controller:

Step	Action
1	Insert the SD card into a PC.
2	Remove the file in the SD Card:\USR\APP directory.
3	Go to the SD Card:\OptionIOConfigurations directory. Result: This directory contains the program files for Standard and Option Systems.
4	Copy the program file corresponding to your needed material configuration. For more details, refer to SD Card content description (see page 74).
5	Paste the program file in the SD Card:\USR\APP directory. NOTE: Only one *.smbk file can exist in the SD Card:\USR\APP directory

Program Files in the SD Card

Program files in the SD Card:\OptionIOConfigurations directory:

Program files	Cartridge	Analog 1 and 2 Analog type	Analog 3 and 4 Analog type
HDisplay_Standard_V1.0.smbk	-	2 analog inputs	-
HDisplay_Option_Temperature_J_V1.0.smbk	TMC2TI2	0...10 V or 4...20 mA	2 temperature inputs J probe
HDisplay_Option_Temperature_K_V1.0.smbk			2 temperature inputs K probe
HDisplay_Option_Temperature_R_V1.0.smbk			2 temperature inputs R probe
HDisplay_Option_Temperature_S_V1.0.smbk			2 temperature inputs S probe
HDisplay_Option_Temperature_B_V1.0.smbk			2 temperature inputs B probe
HDisplay_Option_Temperature_T_V1.0.smbk			2 temperature inputs T probe
HDisplay_Option_Temperature_N_V1.0.smbk			2 temperature inputs N probe
HDisplay_Option_Temperature_E_V1.0.smbk			2 temperature inputs E probe
HDisplay_Option_Temperature_C_V1.0.smbk			2 temperature inputs C probe
HDisplay_Option_Temperature_Ni100_V1.0.smbk			2 temperature inputs Ni100
HDisplay_Option_Temperature_Ni1000_V1.0.smbk			2 temperature inputs Ni1000
HDisplay_Option_Temperature_Pt100_V1.0.smbk			2 temperature inputs Pt100
HDisplay_Option_Temperature_Pt1000_V1.0.smbk			2 temperature inputs Pt1000
HDisplay_Option_AnalogInput_0-10V_V1.0.smbk	TMC2AI2		2 analog inputs 0...10 V
HDisplay_Option_AnalogInput_4-20ma_V1.0.smbk	TMC2AI2		2 analog inputs 4...20 mA
HDisplay_Option_AnalogOutput_0-10V_V1.0.smbk	TMC2AQ2V		2 analog outputs 0...10 V
HDisplay_Option_AnalogOutput_4-20ma_V1.0.smbk	TMC2AQ2C		2 analog outputs 4...20 mA

Chapter 5

Configuring the Unit

Overview

This chapter presents the settings on the XB5DD030/050 units.

What Is in This Chapter?

This chapter contains the following topics:

Topic	Page
Types of Settings	76
System Settings	77

Types of Settings

Introduction

You can use the **Settings** menu to configure the unit.

You can display the XB5DD030/050 **Settings** menu touching two corners of the panel successively while the application is running.

Calling Up the Settings Menu

Step	Action
1	Connect the power supply.
2	Touch successively the top left corner then the bottom right corner within half a second. The touch area is 50 dots by 50 dots.
3	The Settings menu contains 3 tabs: <ul style="list-style-type: none">● Offline: reserved● System: refer to System Settings (<i>see page 77</i>)● Diagnostics: reserved Click a tab to display its settings.

System Settings

Introduction

You can change system settings while the user application is still running. Most of the settings are Schneider Electric reserved used.

Stylus

Use the Stylus to calibrate the screen:

Step	Action
1	In the Setting menu, press the System tab.
2	Press the Stylus button.
3	Press the center of the cross several times to complete calibration of the screen.

Brightness Control

Step	Action
1	In the Setting menu, press the System tab.
2	Press the Brightness button.
3	Press the up/down arrows to adjust the brightness. NOTE: Reducing the brightness could increase the life span of the backlight.



Chapter 6

Configuring the Application

What Is in This Chapter?

This chapter contains the following sections:

Section	Topic	Page
6.1	Settings Pages Flowchart	80
6.2	Settings Pages	84

Section 6.1

Settings Pages Flowchart

What Is in This Section?

This section contains the following topics:

Topic	Page
Settings Pages Flowchart	81
Overview	83

Overview

Settings Pages

The application configuration is composed by several settings pages:

Settings Pages	Description
Password (<i>see page 85</i>)	Ask the setting password to allow access to the application configuration. Appears if a setting password (<i>see page 107</i>) has been configured.
Welcome (<i>see page 86</i>)	You can Load configuration from a USB memory key or start settings.
Languages (<i>see page 87</i>)	You can modify the application language.
Communication (<i>see page 88</i>)	You can modify the communication parameters.
Analogic 1 (<i>see page 90</i>)	You can modify the analog value 1.
Analogic 2	You can modify the analog value 2. Refer to Analogic 1 description (<i>see page 90</i>).
Analogic 3 (<i>see page 95</i>)	You can modify the analog value 3 ⁽¹⁾ .
Analogic 4	You can modify the analog value 4 ⁽¹⁾ . Refer to Analogic 3 description (<i>see page 95</i>).
Cam switch (<i>see page 100</i>)	You can modify the cam switch.
Inputs 1 to 4 (<i>see page 102</i>)	You can modify the digital inputs 1-4.
Inputs 5 to 8 (<i>see page 105</i>)	You can modify the digital inputs 5-8.
Notifications (<i>see page 106</i>)	Alarm threshold triggering notification.
Password (<i>see page 107</i>)	You can set the setting password. If so, the settings password is asked to permit access to the application configuration.
Save (<i>see page 108</i>)	Save your application in a USB memory key.
Theme (<i>see page 109</i>)	You can modify the theme of the application (Light or Dark)
1 Not available in standard system (<i>see page 13</i>).	

Section 6.2

Settings Pages

What Is in This Section?

This section contains the following topics:

Topic	Page
Setting Page: Password	85
Setting Page: Welcome	86
Setting Page: Language	87
Setting Page: Communication	88
Setting Page: Analog Value 1 and 2	90
Setting Page: Analog Value 3 and 4	95
Setting Page: Cam Switch	100
Setting Page: Digital Inputs 1...4	102
Setting Page: Digital Inputs 5...8	105
Setting Page: Notifications	106
Setting Page: Password	107
Setting Page: Save	108
Setting Page: Theme	109

Setting Page: Password

Overview

When you want to enter in the settings pages, if a configuration settings password has been configured (*see page 107*), the following screen appears:

Step	Action
1	Type the password.
2	Click Check Password . Result: The Harmony Display indicates if the proposed password is valid or not.

Resetting Password

If you have lost the password, you can reset the Harmony Display by entering the password ***RE5ET?***. You have 20 seconds to cancel the reset process.

NOTE: Resetting the device resumes the configuration to factory setting. It is recommended to save your configuration before proceeding.

Setting Page: Welcome

Overview

When the Harmony Display starts or when you want to start the configuration, the following screen appears:

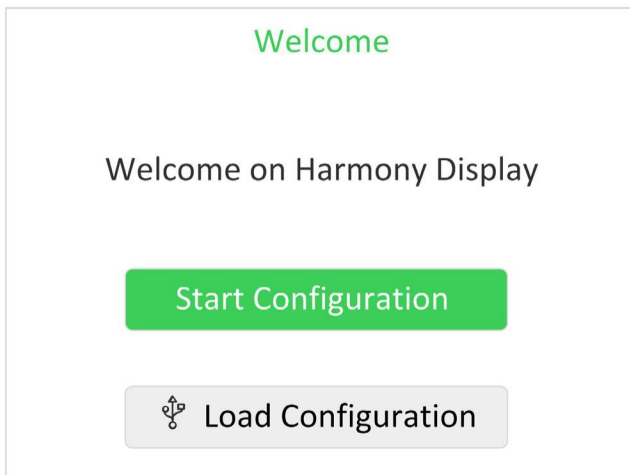

You can start the configuration.

You can Load a configuration in the Harmony Display

Step	Action
1	Connect a USB memory key on the USB1 port.
2	Click Load Configuration .
3	Wait until the configuration is loaded.

Setting Page: Language

Overview

You can modify the language of the application:

Back	Language	Next
ENGLISH	Español	
Français	中文	
Italiano	Portugues	
Deutsch	Русский	

Setting Page: Communication

Overview

You can configure the communication parameters:

Back Communication Next

Which kind of communication configuration do you want?

CUSTOMIZED DEFAULT

If you select **CUSTOM**, you can select the Modbus communication format:

Back Communication Next

How do you want to configure Modbus ?

RTU Slave TCP/IP

NOTE: The communication modifications are recommended for advanced user only.

You can select **RTU Slave** or **TCP/IP**.

Slave RTU

If you select **Slave RTU** (default communication format), you can modify the parameters:

Back	RTU Master		Next
Baudrate :	Slave address	123	
2600	4800	9600	19200
38400			
Data Length	8	Stop Bit	1 2
Parity	None	Even	Odd

TCP/IP

If you select **TCP/IP**, you can modify the Modbus IP Addresses:

Back	Modbus IP		Next
Harmony Display Address			
IP	172	16	90 10
SubNet	255	255	255 0
PLC Address			
IP	172	16	90 11

NOTE: Use the IP address definition standards.

Setting Page: Analog Value 1 and 2

Overview

In RUN MODE, you can display analog value 1 and analog value 2.

In Advanced system, you can use the setpoints to control analog outputs.

Analog Value 1 and 2 - Main Page

You can configure analog values (1...2):

Step	Action
1	Select Enable Page to be able to modify the parameters and to make the Page visible in RUN MODE (<i>see page 112</i>).
2	Type the Unit of the analog value.
3	Type the Name of the analog value.
4	Select the graphical type of the analog value: <ul style="list-style-type: none"> • Value (<i>see page 114</i>) • Bar Graph (<i>see page 115</i>) • View Meter (<i>see page 116</i>)

Analog Value 1 and 2 - Parameters

You can configure the analog value parameters:

Back
Analogic #1
Next

Decimal point - 1234 +

Min 0 Max 10

Setpoint Threshold

Type 0...10 V 4...20 mA

Step	Action
1	Use the + and - buttons to modify the position of the decimal point of the value.
2	Type the minimum and maximum values to display.
3	Select the Type of the value depending on the sensor type: <ul style="list-style-type: none"> ● 0...10 V ● 4...20 mA <p>NOTE: In standard system, the analog inputs of TM211C16R are 0...10V only. To transform one in 4...20 mA, you have to connect a 500 ohm resistor in parallel of the analog input. For more details, refer to Standard system wiring (see page 67).</p>
4	Select Setpoint to make visible and modifiable a setpoint in RUN MODE (see page 121).
5	Select Threshold to be able to define Thresholds.

Example of analog value conversion:

	Min	Max
Physical analog value	0	1000
Displayed Value	-10	50

Displayed
value

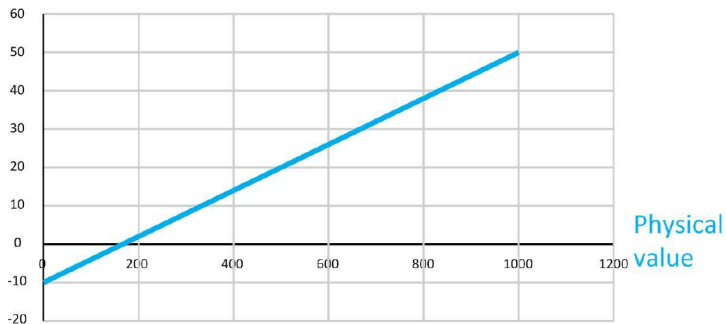





Analog Value 1 and 2 - Threshold



This page is only displayed if you have select **Threshold** on the previous setting page.
 You must set threshold values:

Back
Analogic #1
Next

Threshold

	HH	9
	H	7
	L	3
	LL	1

Relay 1 Threshold

Type each threshold values from **HH** to **LL**.

NOTE: The threshold values are limited by the minimum and maximum values defined in the previous setting page.

Analog Value	Background color page in RUN MODE
$MAX \geq Value \geq HH$	Red
$HH > Value \geq H$	Orange
$H > Value > L$	Normal. Depends on the selected Theme (Light / Dark)
$L \geq Value > LL$	Orange
$LL \geq Value \geq MIN$	Red

Select **Relay Threshold** to make the dedicated relay controlled depending on the thresholds status. Then, select the type of control of the relay (NO or NC):

When the value...	Relay NO	Relay NC
Falls below the L threshold	The contact becomes closed	The contact becomes open
Goes above the H threshold	The contact becomes open	The contact becomes closed

Functioning of the relay threshold:

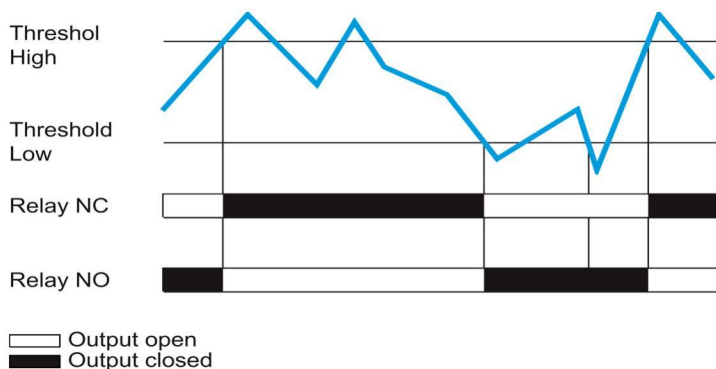

NOTE: By exception, in order to be able to manage relay threshold in temperature applications with TMC2TI2 cartridge option, the threshold relays 1 and 2 (Q0 and Q1) are automatically switched to Analog value 3 and Analog value 4.

Setting Page: Analog Value 3 and 4

Overview

In Standard system, these two pages are not usable.

In Option System, depending on the TMC2 cartridge, you can display:

- TMC2TI2: 2 Analog temperature inputs
- TMC2AI2: 2 Analog inputs (0...10 Vdc or 4...20 mA)
- TMC2AQ2V: 2 Analog voltage outputs (0...10 Vdc)
- TMC2AQ2C: 2 Analog current outputs (4...20 mA)

In Option System, with the 2 analog outputs cartridges (TMC2AQ2V and TMC2AQ2C), the displayed value is the setpoint value. This value is used to control analog output.

In Advanced system, you can display analog input and you can use the setpoints to control analog output.

Analog Value 3 and 4 - Main Page

You can configure analog values (3...4):

Back
Analogic #3
Next

Enable Page

Unit

Name

Value
123

Bar Graph

View Meter

Step	Action
1	Select Enable Page to be able to modify the parameters and to make the Page visible in RUN MODE (<i>see page 112</i>).
2	Type the Unit of the analog value ⁽¹⁾ .
3	Type the Name of the analog value.
4	Select the graphical type of the analog value: <ul style="list-style-type: none"> ● Value (<i>see page 114</i>) ● Bar Graph (<i>see page 115</i>) ● View Meter (<i>see page 116</i>)
1 If you enter the unit "degF" or "DegF", the application converts the analog value from degree Celsius to degree Fahrenheit.	

Analog Value 3 and 4 - Parameters

You can configure the analog value parameters:

Back
Analogic #3
Next

Decimal point - 1234 +

Min Max

Setpoint Threshold

Step	Action
1	Use the + and - buttons to modify the position of the decimal point of the value.
2	Type the minimum and maximum values to display.
3	Select Setpoint to make visible and modifiable a setpoint in RUN MODE (<i>see page 121</i>).
4	Select Threshold to be able to define Thresholds.

Example of analog value conversion:

	Min	Max
Physical analog value	0	1000
Displayed Value	-10	50

Displayed
value

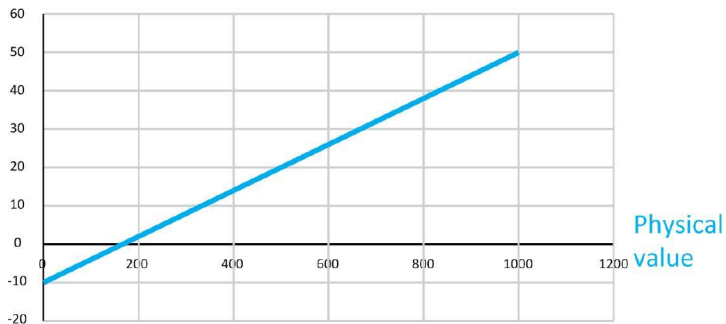

Analogic Inputs 3 and 4 - Page 3: Threshold

This page is only displayed if you have select **Threshold** on the previous page.

You must set threshold values:

Back
Analogic #3
Next

Threshold

	HH	<input style="width: 90%;" type="text" value="18"/>
	H	<input style="width: 90%;" type="text" value="16"/>
	L	<input style="width: 90%;" type="text" value="4"/>
	LL	<input style="width: 90%;" type="text" value="2"/>

Type each threshold values from **HH** to **LL**.

NOTE: The threshold values are limited by the minimum and maximum values defined in the previous setting page.

Analog Value	Background color page in RUN MODE
$MAX \geq Value \geq HH$	Red
$HH > Value \geq H$	Orange
$H > Value > L$	Normal. Depends on the selected Theme (Light / Dark)
$L \geq Value > LL$	Orange
$LL \geq Value \geq MIN$	Red

NOTE: By exception, in order to be able to manage relay threshold in temperature applications with TMC2TI2 cartridge option, the threshold relays 1 and 2 (Q0 and Q1) are automatically switched to Analog value 3 and Analog value 4.

For more details, refer to Relay threshold description. *(see page 93)*

Setting Page: Cam Switch

Overview

In RUN MODE, you can modify the position of the cam switch. Each position can be assigned to digital outputs.

Cam Switch - Main Page

You can activate the Cam switch selector:

Step	Action
1	Select YES to be able to modify the parameters and to make the Page visible in RUN MODE.
2	Type the Name of the cam switch.
3	Select the number of positions of the cam switch.
4	Select the starting position of the cam switch or to start with last position.

In Runtime, the cam switch position is stored.

If the user goes back to configuration and does a modification not related to the cam switch, when going back to runtime, the cam switch keeps its last position.

If the user goes back to configuration and does a modification related to the cam switch, when going back to runtime, the cam switch goes to the initial position configured with the option Start with last position/position number.

Cam Switch Matrix

You can choose which relays are controlled depending on the cam switch position:

Back		CamSwitch					Next	
Pos/Relays		R3	R4	R5	R6	R7	R8	R9
1	Pos1	<input checked="" type="radio"/>	<input checked="" type="radio"/>	<input type="radio"/>	<input checked="" type="radio"/>	<input checked="" type="radio"/>	<input checked="" type="radio"/>	<input checked="" type="radio"/>
2	Pos2	<input type="radio"/>	<input checked="" type="radio"/>	<input type="radio"/>	<input type="radio"/>	<input type="radio"/>	<input type="radio"/>	<input type="radio"/>
3	Pos3	<input type="radio"/>	<input type="radio"/>	<input checked="" type="radio"/>	<input type="radio"/>	<input type="radio"/>	<input type="radio"/>	<input type="radio"/>
4	Pos4	<input type="radio"/>	<input type="radio"/>	<input type="radio"/>	<input checked="" type="radio"/>	<input type="radio"/>	<input type="radio"/>	<input type="radio"/>
5	Pos5	<input type="radio"/>	<input type="radio"/>	<input type="radio"/>	<input checked="" type="radio"/>	<input type="radio"/>	<input type="radio"/>	<input type="radio"/>
6	Pos6	<input type="radio"/>	<input type="radio"/>	<input type="radio"/>	<input type="radio"/>	<input type="radio"/>	<input type="radio"/>	<input type="radio"/>
7	Pos7	<input type="radio"/>	<input type="radio"/>	<input type="radio"/>	<input type="radio"/>	<input type="radio"/>	<input type="radio"/>	<input type="radio"/>

Step	Action
1	For each selectable position 1...7, type the name of the position.
2	For each selectable position, select the relay to activate R3...R9.

NOTE: R8 and R9 are only usable in Advanced System (*see page 13*).



Setting Page: Digital Inputs 1..4

Overview

This page permits to display digital inputs as pilot lights and texts, counters, or hour counters.

Overview

You can activate and select the color of digital inputs:

Back		Inputs 1 to 4		Next	
<	Pilot Light 1	>	<	Counter 2	>
On	Input 1			Input 2	
Off	Input 1 Off		Unit	No Input	
<		>			
<	Hour Meter 3	>	<	Pilot Light 4	>
	Input 3		On	Input 4	
			Off	Input 4 Off	
			<		>

For each input, select the type of digital input:

- None
- **Pilot Light:** pilot light is On when the digital input is On
- **Counter:** count the number of activation of the digital input
- **Hour Meter:** count the time of activation of the digital input.
- None

Pilot Light

Pilot Light 1

On

Off

For a Pilot Light

Step	Action
1	On: Type the text to display when the digital input is On.
2	Off: Type the text to display when the digital input is Off.
3	Select the color of the pilot light when the digital input is On: <ul style="list-style-type: none"> ● White ● Red ● Green ● Blue ● Orange ● Yellow ● White

Counter

Counter 2

Unit

For a Counter

Step	Action
1	Type the input name.
2	Unit: Type the unit of the digital input that is counted.

NOTE: The maximum frequency that can be taken into account is 2 Hz.

Hour Meter

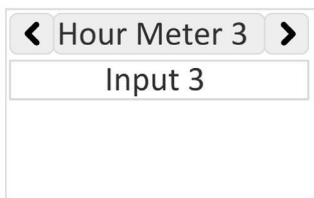

The image shows a configuration window for an hour meter. At the top, there is a header bar with a left-pointing arrow, the text "Hour Meter 3", and a right-pointing arrow. Below this header is a text input field containing the text "Input 3". The rest of the window is empty.

For an hour meter

Step	Action
1	Type the input name.

Setting Page: Digital Inputs 5...8

Overview

This page allows you to configure inputs 5 to 8 as the same as Inputs 1 to 4 Page (*see page 102*).

Setting Page: Notifications

Overview

You can modify the threshold notification:

BackNotificationsNext

Do you want to be notified when
an alarm threshold is triggered?

YES

NO

Notification	Description
YES	In RUN MODE, when an analog value activates its thresholds: <ul style="list-style-type: none">the background color of the dedicated page is modified.the color of the Navigation buttons in RUN MODE is modified. For more details, refer to Notification Page description (<i>see page 119</i>).
NO	No change of background color of the page. No change of the color of the Navigation buttons.

Setting Page: Password

Overview

You can activate and create/modify the setting password:

Back
Password
Next

Do you want to configure a setting password?

YES

NO

Password

Step	Action
1	Click YES.
2	Type the new password. Result: The next time you want to enter in the Settings Pages, the password will be asked <i>(see page 85).</i>

Setting Page: Save

Overview

You can save your configuration in a USB memory key

BackSaveNext

Do you want to save your configuration in a USB key?

YES

NO

Save

Step	Action
1	Click YES.
2	Connect a USB memory key on the USB1 port.
3	Click Save Configuration .
4	Wait until the configuration save ends.

Setting Page: Theme

Overview

You can select the theme of the application depending on your bright work environment:

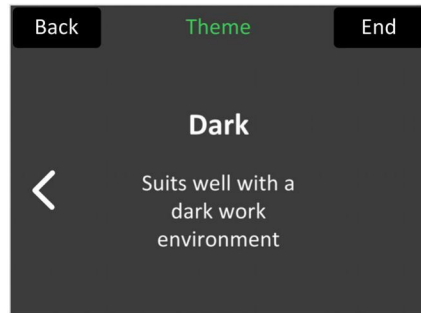
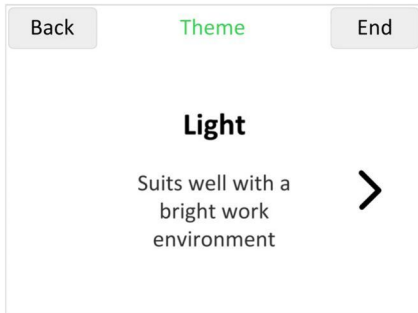



Chapter 7

RUN MODE

What Is in This Chapter?

This chapter contains the following topics:

Topic	Page
Overview	112
Main Pages	114
Analog Thresholds	119
SetPoint	121

Overview

Overview





In RUN MODE, the Harmony Displays show the configured pages (analog values, cam switch, digital inputs).

Restart

If a power-off occurs during RUN MODE, at the next power-on, the Harmony Display starts directly at the previous RUN MODE page.

RUN MODE Navigate

Each RUN MODE page has navigate buttons:

Button	Description
	Go to next Page Once the end of the page list is reached, it goes back to the start.
	Go to previous Page Once the first page is reached, it goes to the last page.
	Go to Settings For more details, refer to Settings Page (<i>see page 83</i>).
 or 	The flashing circle indicates the communication status of the Harmony Display: <ul style="list-style-type: none"> ● Green = OK ● Red = Communication lost with the Modbus Master

RUN MODE Flowchart

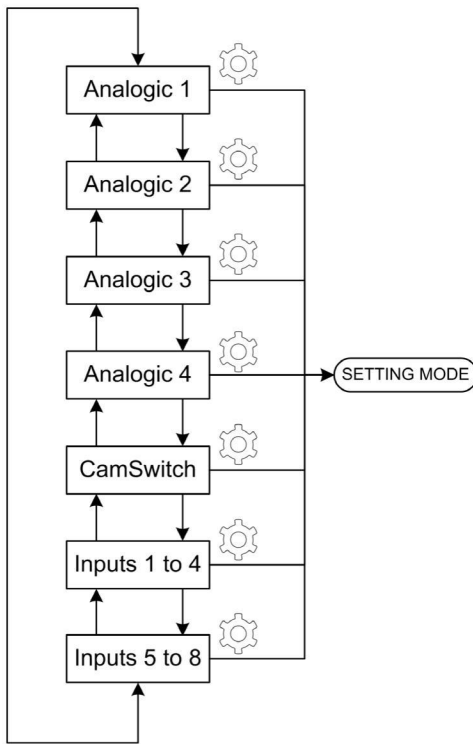

NOTE: The total number of pages depends on the number of enabled pages (analog values, cam switch, digital inputs). If not configured, the page is skipped.

Main Pages

Overview

There are 3 types of pages:

- Analog values:
 - Numerical type (*see page 114*)
 - Bar graph type (*see page 115*)
 - View Meter type (*see page 116*)
- Cam switch (*see page 117*)
- Digital inputs (*see page 118*)

Analog Value Numerical Page

Example of Analog value Numerical Page:

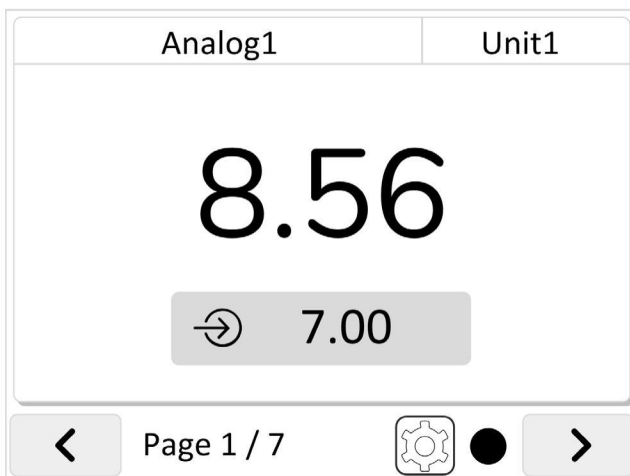

Displayed data:

- Name of the value
- Unit of the value
- Value
- SetPoint (if enabled in the settings (*see page 90*)). Refer to SetPoint description (*see page 121*).

Analog Value Bar Graph Page

Example of Analog value Bar graph Page:

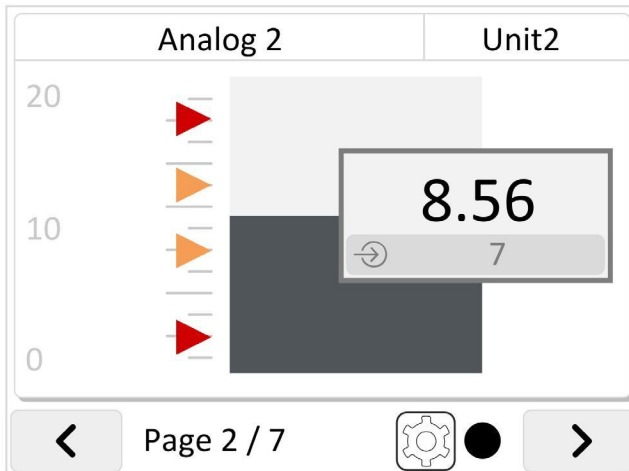

Displayed data:

- Name of the value
- Unit of the value
- Value
- Min and Max
- Threshold (if enabled in the settings *(see page 90)*).
- SetPoint (if enabled in the settings *(see page 90)*). Refer to SetPoint description *(see page 121)*.

Analog Value View Meter Page

Example of Analog value View Meter Page:

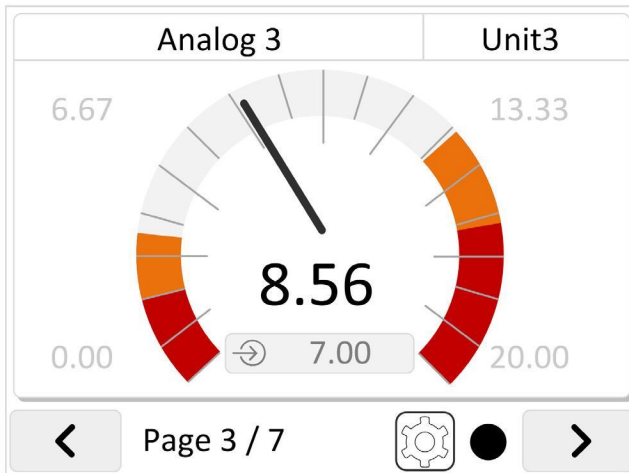

Displayed data:

- Name of the value
- Unit of the value
- Value
- Min and Max
- Threshold (if enabled in the settings *(see page 90)*).
- SetPoint (if enabled in the settings *(see page 90)*). Refer to SetPoint description *(see page 121)*.

Cam Switch Page

Example of Cam switch Page (with 7 positions):

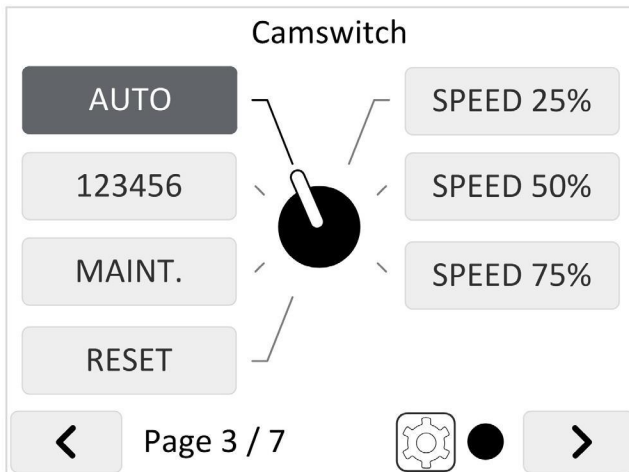

To change the cam switch position, click another position name to activate it.

Change the position of the cam switch to control, via the configured cam switch matrix (*see page 101*), the digital outputs.

Digital Input Page

Example of Digital Input Page:

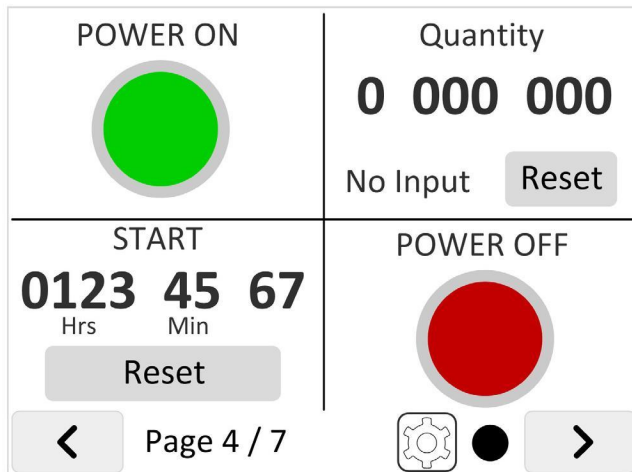

Each digital input can be set as:

- **None:** The dedicated area is empty
- **Pilot Light:**
 - When the digital input is On, the pilot light is On and the dedicated text is displayed
 - When the digital input is Off, the pilot light is Off and the dedicated text is displayed
- **Counter:** count the number of activation of the digital input
Press **Reset** to reset the counter.
- **Hour Meter:** count the time of activation of the digital input.
Press **Reset** to reset the Hour meter.

Analog Thresholds

Overview

Analog Thresholds

For each analog value, if thresholds are activated in the settings (*see page 91*), the background color of the corresponding page changes depending on the analog value:

Color	Description
Red	$MAX > \text{analog value} \geq \text{HH threshold}$ $Min \leq \text{analog value} \leq \text{LL threshold}$
Orange	$\text{HH threshold} > \text{analog value} \geq \text{H threshold}$ $\text{LL threshold} < \text{analog value} \leq \text{L threshold}$

Example of a threshold activated on the actually displayed analog value :

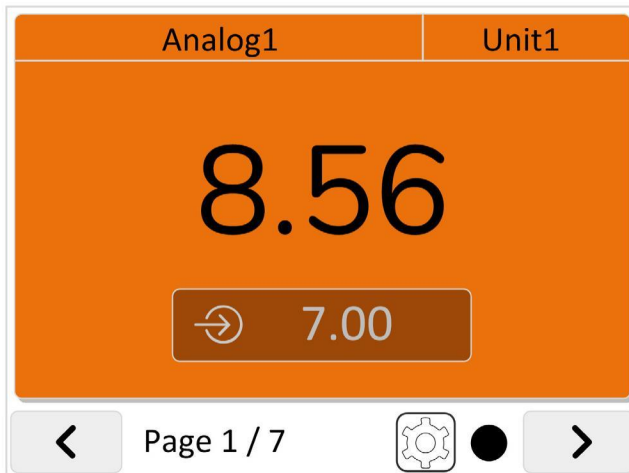

Analog Thresholds Notification

If the Notification function is activated (*see page 106*), the navigation buttons color change when an analog value threshold is triggered.

Example of a threshold activated for another analog value:

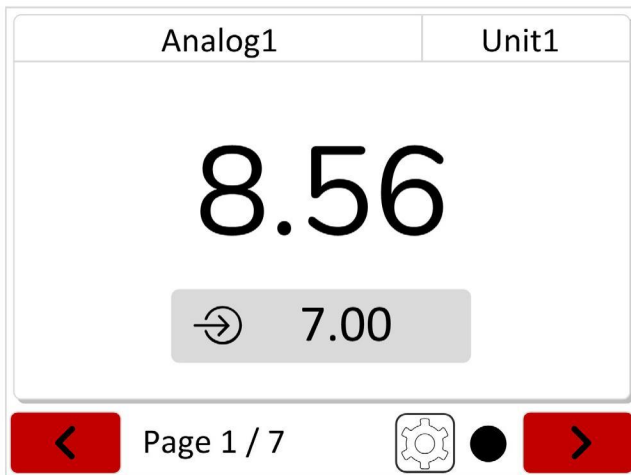

SetPoint

Overview

On each Analog value page, if the SetPoint has been enabled, the SetPoint value is displayed.

Example of Analog value Numerical value Page:

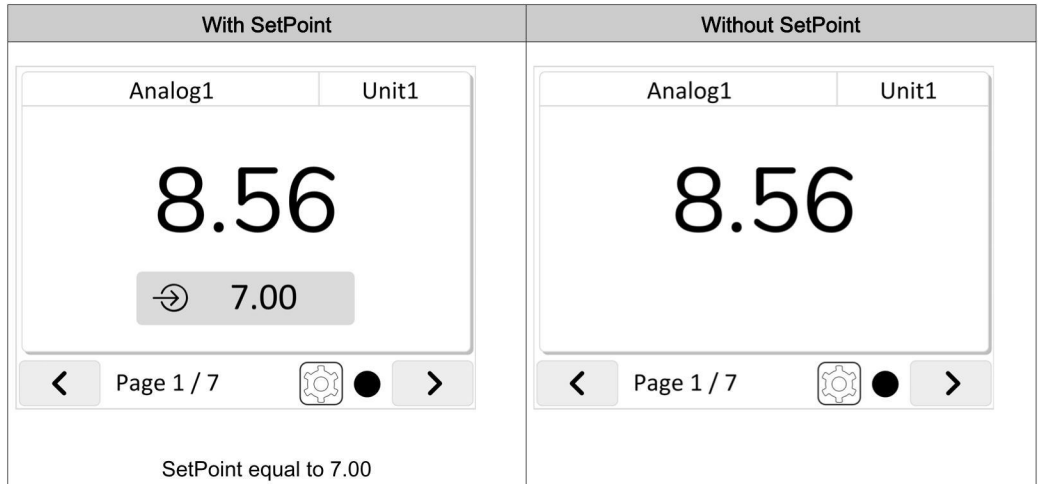

SetPoint Modification

Proceed as follow to modify the SetPoint value:

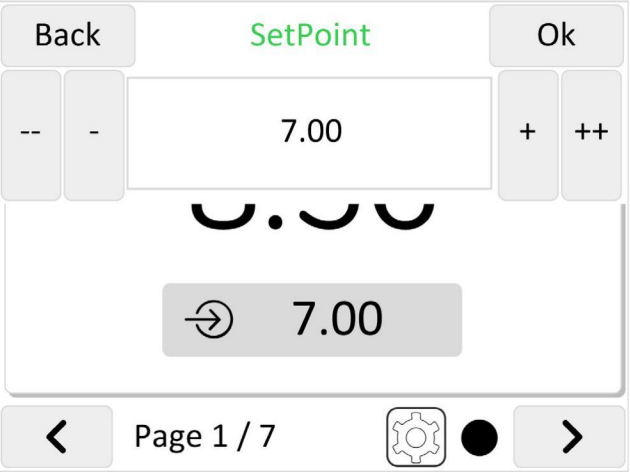
Step	Action
1	<p>Press the SetPoint area. Result: The SetPoint tools are displayed:</p> 
2	<p>Press the SetPoint value to type a new SetPoint value.</p>
3	<p>Press the buttons to modify the SetPoint value:</p> <ul style="list-style-type: none"> -- decrease SetPoint value (10% of MAX-MIN value) - decrease SetPoint value (1% of MAX-MIN value) + increase SetPoint value (1% of MAX-MIN value) ++ increase SetPoint value (10% of MAX-MIN value) <p>For example, if MIN=0 and MAX=5000:</p> <ul style="list-style-type: none"> -- decrease SetPoint value by 500 - decrease SetPoint value by 50 + increase SetPoint value by 50 ++ increase SetPoint value by 500
4	<p>Click Ok.</p>

SetPoint Usage

- Standard System:
The SetPoint is only for information. The SetPoint value is not used by the PLC.
- Option System:
 - For Analog value 1 and 2:
The SetPoint is only for information. The SetPoint value is not used by the PLC.
 - For Analog value 3 and 4 with TMC2TI2 and TMC2AI2 cartridge:
The SetPoint is only for information. The SetPoint value is not used by the PLC.
 - For Analog value 3 and 4 with TMC2AQ2V and TMC2AQ2C cartridge:
The SetPoint value is given to the analog output.
- Advanced System:
The SetPoint value can be read by the PLC and, for example, can be given to an analog output.



Chapter 8

Memory Mapping

Memory Mapping

Overview

The Harmony Display is a Modbus Slave.

The Harmony Display must communicate with a Modbus Master (PLC, iPC, SCADA, and so on).

The Harmony Display Memory Mapping is separated in several categories:

Categories	Description
System <i>(see page 126)</i>	The Modbus Master and the Harmony Display can check their communication.
Analog inputs <i>(see page 127)</i>	The Modbus Master writes the analog inputs values.
Analog outputs <i>(see page 127)</i>	The Modbus Master writes the analog outputs values.
Setpoints <i>(see page 129)</i>	The Modbus Master reads the setpoints of the analog values.
Thresholds <i>(see page 128)</i>	The Modbus Master reads threshold of the analog values.
Digital I/O <i>(see page 130)</i>	The Modbus Master writes the digital inputs and reads the digital outputs.
Cam switch <i>(see page 129)</i>	The Modbus Master reads the cam switch position.

Harmony Display Memory Mapping - System

Modbus Address	Name/Value	Access by Modbus Master	Type/form at	Description	Linked to Display Page
%MW8:X0	Heartbeat from Modbus Master	W	BIT	Status of Modbus Master (cyclic timer) The frequency is 2...5 seconds	All
%MW8:X1	Heartbeat function	W	BIT	0: heartbeat function OFF 1: heartbeat function ON	All
%MW11:X0	Heartbeat from Harmony Display	R	BIT	Feedback of Harmony Display: Copy of Heartbeat from PLC. This bit can be used to detect when the communication is broken.	All
W: written by Modbus Master R: read by Modbus Master					

On the Modbus Master, you can create a heartbeat function (cyclic timer) at a frequency of 2...5 seconds.

The Modbus Master writes this heartbeat in the %MW8 : X0 bit.

If the Harmony Display heartbeat function is ON (%MW8 : X1=1), the Harmony Display:

- Check the heartbeat in %MW8 : X0 bit:
 - If a 10 s timeout is detected:
 - “Communication timeout” appears on the Harmony Display.
 - The displayed data are not updated.
- The Harmony Display writes the %MW8 : X0 value in %MW11 : X0.
This permits the Modbus Master to detect when the communication with the Harmony Display is broken and, if needed, to reset the outputs.

Harmony Display Memory Mapping - Analog Inputs

Modbus Address	Name/Value	Access by Modbus Master	Type/form at	Description	Linked to Display Page
%MW1	Analog value 1	W	WORD	Scaled by Harmony display	Analogic #1 <i>(see page 90)</i>
%MW2	Analog value 2	W	WORD	Scaled by Harmony display	Analogic #2 <i>(see page 90)</i>
%MW3	Analog value 3	W	WORD	Scaled by Harmony display	Analogic #3 <i>(see page 95)</i>
%MW4	Analog value 4	W	WORD	Scaled by Harmony display	Analogic #4 <i>(see page 95)</i>
W: written by Modbus Master					

Harmony Display Memory Mapping - Analog Outputs

Modbus Address	Name/Value	Access by Modbus Master	Type/form at	Description	Linked to Display Page
%MW8	Analog output 3	R	WORD	Value scaled by Harmony display for analog output 3 (0...10000 for a 0...10V, 4000...20000 for 4...20 mA)	Analogic #3 <i>(see page 95)</i>
%MW9	Analog output 4	R	WORD	Value scaled by Harmony display for analog output 4 (0...10000 for a 0...10V, 4000...20000 for 4...20 mA)	Analogic #4 <i>(see page 95)</i>
R: read by Modbus Master					

Harmony Display Memory Mapping - Thresholds

Modbus Address	Name/Value	Access by Modbus Master	Type/form at	Description	Linked to Display Page
%MF22	Threshold HH Analog 1	R	DWORD	Very High threshold value of analog value 1	Analogic #1 <i>(see page 90)</i>
%MF24	Threshold H Analog 1	R	DWORD	High threshold value of analog value 1	
%MF26	Threshold L Analog 1	R	DWORD	Low threshold value of analog value 1	
%MF28	Threshold LL Analog 1	R	DWORD	Very Low threshold value of analog value 1	
%MF32	Threshold HH Analog 2	R	DWORD	Very High threshold value of analog value 2	Analogic #2 <i>(see page 90)</i>
%MF34	Threshold H Analog 2	R	DWORD	High threshold value of analog value 2	
%MF36	Threshold L Analog 2	R	DWORD	Low threshold value of analog value 2	
%MF38	Threshold LL Analog 2	R	DWORD	Very Low threshold value of analog value 2	
%MF42	Threshold HH Analog 3	R	DWORD	Very High threshold value of analog value 3	Analogic #3 <i>(see page 95)</i>
%MF44	Threshold H Analog 3	R	DWORD	High threshold value of analog value 3	
%MF46	Threshold L Analog 3	R	DWORD	Low threshold value of analog value 3	
%MF48	Threshold LL Analog 3	R	DWORD	Very Low threshold value of analog value 3	
%MF52	Threshold HH Analog 4	R	DWORD	Very High threshold value of analog value 4	Analogic #4 <i>(see page 95)</i>
%MF54	Threshold H Analog 4	R	DWORD	High threshold value of analog value 4	
%MF56	Threshold L Analog 4	R	DWORD	Low threshold value of analog value 4	
%MF58	Threshold LL Analog 4	R	DWORD	Very Low threshold value of analog value 4	
R: read by Modbus Master					

Harmony Display Memory Mapping - Setpoints

Modbus Address	Name/Value	Access by Modbus Master	Type/format	Description	Linked to Display Page
%MF12	SetPoint1	R	DWORD	Setpoint value of Analog input 1	Analogic #1 (see page 90)
%MF14	SetPoint2	R	DWORD	Setpoint value of Analog input 2	Analogic #2 (see page 90)
%MF16	SetPoint3	R	DWORD	Setpoint value of Analog input 3	Analogic #3 (see page 95)
%MF18	SetPoint4	R	DWORD	Setpoint value of Analog input 4	Analogic #4 (see page 95)
R: read by Modbus Master					

Harmony Display Memory Mapping - Cam Switch

Modbus Address	Name/Value	Access by Modbus Master	Type/format	Description	Linked to Display Page
%MW20	Cam switch position	R	WORD	1: position 1 selected ... 7: position 7 selected	Cam switch (see page 100)
R: read by Modbus Master					

Harmony Display Memory Mapping - Digital I/O

Modbus Address	Name/Value	Access by Modbus Master	Type/form at	Description	Linked to Display Page
%MW9	Digital inputs	W	WORD	Bit 0 = input 1 (pilot light 1) ... Bit 7 = input 8 (pilot light 8)	Inputs 1 to 4 (<i>see page 102</i>) Inputs 5 to 8 (<i>see page 105</i>)
%MW10	Digital outputs	R	WORD	Bit 0: controlled by the Relay 1 threshold function	Analogic #1 (<i>see page 90</i>)
				Bit 1: controlled by the Relay 2 threshold function	Analogic #2 (<i>see page 90</i>)
				Bit 2...bit 8: controlled by R3...R9 from the cam switch matrix	Cam switch (<i>see page 100</i>)
W: written by Modbus Master R: read by Modbus Master					

Chapter 9

Maintenance

Overview

This chapter explains how to maintain your XB5DD030/050 units.

What Is in This Chapter?

This chapter contains the following topics:

Topic	Page
Regular Cleaning	132
Periodic Check Points	134

Regular Cleaning

Cleaning the display

NOTICE

EQUIPMENT DAMAGE

- Power off the unit before cleaning it.
- Do not use hard or pointed objects to operate the touch panel, since it can damage the panel surface.
- Do not use paint thinner, organic solvents, or a strong acid compound to clean the unit.

Failure to follow these instructions can result in equipment damage.

When the surface or the frame of the display gets dirty, soak a soft cloth in water with a neutral detergent, wring the cloth tightly and wipe the display.

Chemical Substances

The products in the following table can be used when cleaning the unit:

Kinds of fluid	Company	Product designation	Concentration	Temperature °C (°F)	pH Value
Cleaning agents in the food and beverage industry	Ecolab	Topmaxx 422	5	40 (104)	1% : pH=13
	Ecolab	P3 Topax M 95	5	40 (104)	1% : pH=12.3
	Ecolab	P3 Oxonia Active	3	40 (104)	
	Ecolab	P3 Topax 52 FR	5	40 (104)	1% : pH=2
	Ecolab	P3 Topax 36	5	40 (104)	
	Ecolab	P3 Luboklar MH	0.7	40 (104)	
	Johnson Diversey	Divosan 2000	1	25 (77)	100% : pH=7
	Johnson Diversey	Diverfoam Septiplus	5	25 (77)	3% : pH=8.3
	Johnson Diversey	Acifoam	5	25 (77)	1% : pH=2.2
	Johnson Diversey	HD Plus Foam	5	25 (77)	1% : pH=12.9
	Johnson Diversey	Oxofoam	5	25 (77)	1% : pH=12.7
	Johnson Diversey	Endoroplus VE6	5	25 (77)	1% : pH=12.1
	Johnson Diversey	Endoroforce VE2	5	25 (77)	1% : pH=12.5
	Johnson Diversey	Endorocid VE10	5	25 (77)	1% : pH=2
Diverse		Water	100	50 (122)	
		Milk	100	25 (77)	
		Methanol	10	25 (77)	
Oils		ASTM 1	100	25 (77)	
		IRM 902	100	25 (77)	
		IRM 903	100	25 (77)	
		Cerechlor/IRM 903	50/50	25 (77)	
		Syntopon B	3	25 (77)	
Cutting oils	Ecocut	HBN 16LE	Pure	25 (77)	
	Quakercool	7101H	Emulsion	25 (77)	
	Quakercool	2769	Soluble / Synthetic	25 (77)	
	Quakercool	3750H	Micro-emulsion	25 (77)	

Periodic Check Points

Operation Environment

Refer to the Environmental Specifications (*see page 31*).

Electrical Specifications

The input voltage must be within 20.4 to 28.8 Vdc.

Related Items

- Are all power cords and cables connected properly? Are there any loose cables?
- Are all mounting brackets holding the unit securely?
- Are there scratches or traces of dirt on the installation gasket?

Chapter 10

Troubleshooting

Troubleshooting Checklists

Introduction

When there is a detected problem, go through the checklist and follow the instructions given.

Here are the main detected problems that may occur when using XB5DD030/050 unit.

- Harmony Display touch panel is blank,
- Connected equipment cannot be used,
- Harmony Display does not respond or responds very slowly,
- Harmony Display beeps when powered on.

NOTE: Contact your local Schneider Electric vendor or your local distributor.

Harmony Display Touch Panel is Blank

If the Harmony Display display is blank, perform the following check steps:

Step	Check/Operation	Solution
1	Is the Harmony Display using the correct rated voltage?	Verify the power supply connections and levels.
2	Is the power supply off or disconnected?	Follow the instructions in this manual for reconnecting the power supply.
3	Is the backlight lit?	Potential detected problem with the unit. Contact your local Schneider Electric distributor.
4	Is the detected problem resolved?	If none of the previous steps fixed the blank panel display detected problem, then verify the hardware.

Connected Equipment Cannot be Used

If the Harmony Display does not communicate with connected equipment, perform the following check steps:

Step	Check/Operation	Solution
1	Is the power supply off or disconnected?	Verify the power supply connections and levels.
2	Is the communication cable connected correctly?	Refer to the associated protocol manual for information about cable diagrams.
3	Is the detected problem resolved?	If none of the previous steps fixed the communication detected problem, then verify the hardware.

Harmony Display Does Not Respond When Pressed

If the Harmony Display is either not responding when pressed or if its response time is very slow, perform the following check steps:

Step	Check/Operation	Solution
1	Disconnect all the cables except the power cable.	-
2	If touch response is slow, the target CPU may be very busy communicating with external equipment.	<ul style="list-style-type: none">● If you are using serial communication, verify the communication speed between the target and equipment is optimized. If none of the proposed options work, contact your Schneider Electric Technical Support for optimizing your project.

Target Beeps When Powered ON

A continuous beep from the target means that system files are corrupted. Contact your local Schneider Electric distributor.

Harmony Display Communication Issue

A continuous beep from the target means that system files are corrupted. Contact your local Schneider Electric distributor.



A

accessories, *22*

C

Certifications and Standards, *26*
Connecting the Power Cord, *55*
Connecting the Power Supply, *58*

E

Ethernet
Cable connector, *63, 64*

G

Grounding, *60*

I

Installation
Procedures, *49*
with a Modbus Master, *15, 72*
with M221, *13, 14, 66, 68, 69, 73, 74*

M

Maintenance
Check points, *134*
Cleaning, *132*

P

Part number
XB5D030, *18*
XB5D050, *18*
Parts Identification and Functions, *23*
Power plug, *55*

S

Settings
menu, *76*
Specifications
COM, *37*
COM1, *36, 37*
Display, *33*
General, *30*
Interfaces, *36*
System Settings, *77*

T

Troubleshooting, *135*

U

USB
Mini-B, *62*
Port, *62*
Standard A, *62*